

güney
vana & armatür



*New
Collection*



2024

HAKKIMIZDA

Güney Vana Armatür 2000 yılında küresel vana üretimi ile imalat sektörüne adım attı. Kurulduğu günden bu yana ortaya koyduğu istikrarlı performansı. armatür üretimi ile ivme kazanmıştır. Küresel vanalar. mutfak ve banyo armatürlerinin döküm süreci dahil tüm aşamaları tesislerimizde gerçekleştirilmektedir. Müşteri memnuniyetini ilke edinmiş firmamız yurtiçi ve yurtdışında ciddi bir pazar ağına sahiptir.

Güney Vana Armatür olarak misyonumuz; kaliteli. güvenilir ve yenilikçi bir politika izleyerek müşterilerimize en iyi hizmeti sunmaktır.

Başlıca vizyonumuz; sektördeki hedeflerimize ulaşarak ülkemizi yedi kıtada en iyi şekilde temsil etmektir.



İÇİNDEKİLER

JETTA	4	TEK GİRİŞLİ BATARYALAR	36
STELLA	5	ARA MUSLIKLAR	38
GOLF	6	BATARYA EK ÜRÜNLER	41
STAR	7	FOTOSELLİ BATARYALAR	44
NEPTÜN	8	ENDÜSTRİYEL BATARYALAR	45
LOFT	9	SPECIAL ÜRÜNLER	51
POLO	12	DUŞ SİSTEMLERİ	54
SİDE	13	PASLANMAZ ÜRÜNLER	62
ELİTE	14	AKSESUARLAR	64
MARS	15		
HERA	17		
EFES	18		
ASOS	19		
KARE	20		
AVANOS	22		
LARA	24		
VİSTA	30		
ACEM	34		

JETTA

NEW



35Ø
TS EN 817

BANYO BATARYASI

- Ürünümsüz MS58/MS63 oranında alçak basınç pirinç külçeden üretilmiştir.
- Yüzey kaplaması 0.12 ile 0.16 mikron krom kaplamadır.
- 25 bar basınca dayanıklı seramik kartuş kullanılmaktadır.
- Tesisat bağlantıları G 1/2'dir.
- Koli içi 12 adet



BATHROOM FAUCET

- Our product is made of MS58/MS63 brass low pressure ingots
- Surface coating is 0.16 mm chrome coating
- 25 bar pressure resistant ceramic cartridge used
- Hand shower connections are G 1/2
- Box 12 pieces

FİYAT / PRICE

50594

1686.00

NEW



35Ø
TS EN 817

KUĞU EVİYE BATARYASI

- Su tasarrufu özel aeratör (Köpük akış, kireç kırıcı, debi değeri: 8lt/dk)
- İdeal çalışma basıncı 3-4 Bar
- Ürünümsüz ms58/ms63 oranında alçak basınç pirinç külçeden üretilmiştir.
- Yüzey kaplaması 0.3 mikron krom 7 mikron nikel kaplamadır.
- 360 derece döner boruludur
- 25 bar basınca dayanıklı seramik kartuş kullanılmaktadır.
- 3/8 m-10 bar basınca dayanıklı çelik örgülü flex kullanılmıştır.
- Koli içi 12 adet



KITCHEN FAUCET

- Water saving special aerator (foam flow, lime breaker, flow rate: 8lt / min)
- Ideal working pressure 3-4 Bar
- Our product is made of MS58/MS63 brass low pressure ingots
- Surface coating is 0.16 mm chrome coating
- 360 degree rotating tube
- 25 bar pressure resistant ceramic cartridge used
- G 3/8 M-10 25 bar pressure resistant steel braided flex used
- Box 12 pieces

FİYAT / PRICE

50595

1360.00

NEW



35Ø
TS EN 817

LAVABO BATARYASI

- Su tasarrufu özel aeratör (Köpük akış, kireç kırıcı, debi değeri: 8lt/dk)
- İdeal çalışma basıncı 3-4 Bar
- Ürünümsüz ms58/ms63 oranında alçak basınç pirinç külçeden üretilmiştir.
- Yüzey kaplaması 0.3 mikron krom 7 mikron nikel kaplamadır.
- 25 bar basınca dayanıklı seramik kartuş kullanılmaktadır.
- 3/8 m-10 bar basınca dayanıklı çelik örgülü flex kullanılmıştır.



WASH BASIN FAUCET

- Water saving special aerator (foam flow, lime breaker, flow rate: 8lt / min)
- Ideal working pressure 3-4 Bar
- Our product is made of MS58/MS63 brass low pressure ingots
- Surface coating is 0.16 mm chrome coating
- 25 bar pressure resistant ceramic cartridge used
- G 3/8 M-10 25 bar pressure resistant steel braided flex used

FİYAT / PRICE

50596

1778.00



NEW



35Ø
TS EN 817

BANYO BATARYASI

- Ürünüümüz MS58/MS63 oranında alçak basınç pirinç külçeden üretilmiştir.
- Yüzey kaplaması 0.12 ile 0.16 mikron krom kaplamadır.
- 25 bar basınca dayanıklı seramik kartuş kullanılmaktadır.
- Tesiilat bağlantıları G 1/2'dir.
- Koli içi 12 adet



BATHROOM FAUCET

- Our product is made of MS58/MS63 brass low pressure ingots
- Surface coating is 0.16 mm chrome coating
- 25 bar pressure resistant ceramic cartridge used
- Hand shower connections are G ½
- Box 12 pieces

FİYAT / PRICE

50543

1666.00

NEW



35Ø
TS EN 817

KUĞU EVİYE BATARYASI

- Su tasarrufu özel aeratör (Köpük akış, kireç kırıcı, debi değeri: 8lt/dk)
- İdeal çalışma basıncı 3-4 Bar
- Ürünüümüz ms58/ms63 oranında alçak basınç pirinç külçeden üretilmiştir.
- Yüzey kaplaması 0.3 mikron krom 7 mikron nikel kaplamadır.
- 360 derece döner boruludur
- 25 bar basınca dayanıklı seramik kartuş kullanılmaktadır.
- 3/8 m-10 bar basınca dayanıklı çelik örgülü flex kullanılmıştır.
- Koli içi 12 adet



KITCHEN FAUCET

- Water saving special aerator (foam flow, lime breaker, flow rate: 8lt / min)
- Ideal working pressure 3-4 Bar
- Our product is made of MS58/MS63 brass low pressure ingots
- Surface coating is 0.16 mm chrome coating
- 360 degree rotating tube
- 25 bar pressure resistant ceramic cartridge used
- G 3/8 M-10 25 bar pressure resistant steel braided flex used
- Box 12 pieces

FİYAT / PRICE

50544

878.00

NEW



35Ø
TS EN 817

LAVABO BATARYASI

- Su tasarrufu özel aeratör (Köpük akış, kireç kırıcı, debi değeri: 8lt/dk)
- İdeal çalışma basıncı 3-4 Bar
- Ürünüümüz ms58/ms63 oranında alçak basınç pirinç külçeden üretilmiştir.
- Yüzey kaplaması 0.3 mikron krom 7 mikron nikel kaplamadır.
- 25 bar basınca dayanıklı seramik kartuş kullanılmaktadır.
- 3/8 m-10 bar basınca dayanıklı çelik örgülü flex kullanılmıştır.



WASH BASIN FAUCET

- Water saving special aerator (foam flow, lime breaker, flow rate: 8lt / min)
- Ideal working pressure 3-4 Bar
- Our product is made of MS58/MS63 brass low pressure ingots
- Surface coating is 0.16 mm chrome coating
- 25 bar pressure resistant ceramic cartridge used
- G 3/8 M-10 25 bar pressure resistant steel braided flex used

FİYAT / PRICE

50545

1448.00

GOLF

NEW

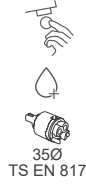

BANYO BATARYASI

- Ürünümüz MS58/MS63 oranında alçak basınç pirinç külçeden üretilmiştir.
- Yüze kaplaması 0.12 ile 0.16 mikron krom kaplamadır.
- 25 bar basınca dayanıklı seramik kartuş kullanılmaktadır.
- Tesisat bağlantıları G 1/2'dir.
- Koli içi 12 adet



BATHROOM FAUCET

- Our product is made of MS58/MS63 brass low pressure ingots
- Surface coating is 0.16 mm chrome coating
- 25 bar pressure resistant ceramic cartridge used
- Hand shower connections are G ½
- Box 12 pieces

FİYAT / PRICE

50591

1658.00

NEW

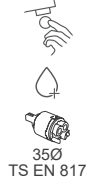

KUĞU EVİYE BATARYASI

- Su tasarrufu özel aeratör (Köpük akış, kireç kırıcı, debi değeri: 8lt/dk)
- İdeal çalışma basıncı 3-4 Bar
- Ürünümüz ms58/ms63 oranında alçak basınç pirinç külçeden üretilmiştir.
- Yüze kaplaması 0.3 mikron krom 7 mikron nikel kaplamadır.
- 360 derece döner boruludur
- 25 bar basınca dayanıklı seramik kartuş kullanılmaktadır.
- 3/8 m-10 bar basınca dayanıklı çelik örgülü flex kullanılmıştır.
- Koli içi 12 adet



KITCHEN FAUCET

- Water saving special aerator (foam flow, lime breaker, flow rate: 8lt / min)
- Ideal working pressure 3-4 Bar
- Our product is made of MS58/MS63 brass low pressure ingots
- Surface coating is 0.16 mm chrome coating
- 360 degree rotating tube
- 25 bar pressure resistant ceramic cartridge used
- G 3/8 M-10 25 bar pressure resistant steel braided flex used
- Box 12 pieces

FİYAT / PRICE

50592

1130.00

NEW



LAVABO BATARYASI

- Su tasarrufu özel aeratör (Köpük akış, kireç kırıcı, debi değeri: 8lt/dk)
- İdeal çalışma basıncı 3-4 Bar
- Ürünümüz ms58/ms63 oranında alçak basınç pirinç külçeden üretilmiştir.
- Yüze kaplaması 0.3 mikron krom 7 mikron nikel kaplamadır.
- 25 bar basınca dayanıklı seramik kartuş kullanılmaktadır.
- 3/8 m-10 bar basınca dayanıklı çelik örgülü flex kullanılmıştır.



WASH BASIN FAUCET

- Water saving special aerator (foam flow, lime breaker, flow rate: 8lt / min)
- Ideal working pressure 3-4 Bar
- Our product is made of MS58/MS63 brass low pressure ingots
- Surface coating is 0.16 mm chrome coating
- 25 bar pressure resistant ceramic cartridge used
- G 3/8 M-10 25 bar pressure resistant steel braided flex used

FİYAT / PRICE

50593

1340.00

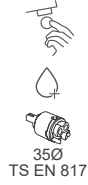

BANYO BATARYASI

- Ürünümsüz MS58/MS63 oranında alçak basınç pirinç külçeden üretilmiştir.
- Yüzey kaplaması 0.12 ile 0.16 mikron krom kaplamadır.
- 25 bar basınca dayanıklı seramik kartuş kullanılmaktadır.
- Tesisat bağlantıları G 1/2'dir.
- Koli içi 12 adet



BATHROOM FAUCET

- Our product is made of MS58/MS63 brass low pressure ingots
- Surface coating is 0.16 mm chrome coating
- 25 bar pressure resistant ceramic cartridge used
- Hand shower connections are G 1/2
- Box 12 pieces

FİYAT / PRICE

50546

1848.00

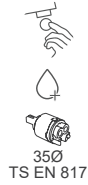

KUĞU EVİYE BATARYASI

- Su tasarrufu özel aeratör (Köpük akış, kireç kırıcı, debi değeri: 8lt/dk)
- İdeal çalışma basıncı 3-4 Bar
- Ürünümsüz ms58/ms63 oranında alçak basınç pirinç külçeden üretilmiştir.
- Yüzey kaplaması 0.3 mikron krom 7 mikron nikel kaplamadır.
- 360 derece döner boruludur
- 25 bar basınca dayanıklı seramik kartuş kullanılmaktadır.
- 3/8 m-10 bar basınca dayanıklı çelik örgülü flex kullanılmıştır.
- Koli içi 12 adet



KITCHEN FAUCET

- Water saving special aerator (foam flow, lime breaker, flow rate: 8lt / min)
- Ideal working pressure 3-4 Bar
- Our product is made of MS58/MS63 brass low pressure ingots
- Surface coating is 0.16 mm chrome coating
- 360 degree rotating tube
- 25 bar pressure resistant ceramic cartridge used
- G 3/8 M-10 25 bar pressure resistant steel braided flex used
- Box 12 pieces

FİYAT / PRICE

50547

1168.00

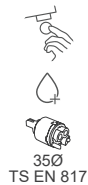

LAVABO BATARYASI

- Su tasarrufu özel aeratör (Köpük akış, kireç kırıcı, debi değeri: 8lt/dk)
- İdeal çalışma basıncı 3-4 Bar
- Ürünümsüz ms58/ms63 oranında alçak basınç pirinç külçeden üretilmiştir.
- Yüzey kaplaması 0.3 mikron krom 7 mikron nikel kaplamadır.
- 25 bar basınca dayanıklı seramik kartuş kullanılmaktadır.
- 3/8 m-10 bar basınca dayanıklı çelik örgülü flex kullanılmıştır.



WASH BASIN FAUCET

- Water saving special aerator (foam flow, lime breaker, flow rate: 8lt / min)
- Ideal working pressure 3-4 Bar
- Our product is made of MS58/MS63 brass low pressure ingots
- Surface coating is 0.16 mm chrome coating
- 25 bar pressure resistant ceramic cartridge used
- G 3/8 M-10 25 bar pressure resistant steel braided flex used

FİYAT / PRICE

50548

1570.00

NEPTÜN

NEW

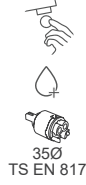

BANYO BATARYASI

- Ürünümsüz MS58/MS63 oranında alçak basınç pirinç külçeden üretilmiştir.
- Yüzeı kaplaması 0.12 ile 0.16 mikron krom kaplamadır.
- 25 bar basınca dayanıklı seramik kartuş kullanılmaktadır.
- Tesiset bağlantıları G 1/2'dir.
- Koli içi 12 adet



BATHROOM FAUCET

- Our product is made of MS58/MS63 brass low pressure ingots
- Surface coating is 0.16 mm chrome coating
- 25 bar pressure resistant ceramic cartridge used
- Hand shower connections are G 1/2
- Box 12 pieces

FİYAT / PRICE

50591

1658.00

NEW

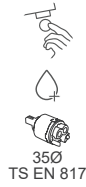

KUĞU EVİYE BATARYASI

- Su tasarrufu özel aeratör (Köpük akış, kireç kırıcı, debi değeri: 8lt/dk)
- İdeal çalışma basıncı 3-4 Bar
- Ürünümsüz ms58/ms63 oranında alçak basınç pirinç külçeden üretilmiştir.
- Yüzeı kaplaması 0.3 mikron krom 7 mikron nikel kaplamadır.
- 360 derece döner boruludur
- 25 bar basınca dayanıklı seramik kartuş kullanılmaktadır.
- 3/8 m-10 bar basınca dayanıklı çelik örgülü flex kullanılmıştır.
- Koli içi 12 adet



KITCHEN FAUCET

- Water saving special aerator (foam flow, lime breaker, flow rate: 8lt / min)
- Ideal working pressure 3-4 Bar
- Our product is made of MS58/MS63 brass low pressure ingots
- Surface coating is 0.16 mm chrome coating
- 360 degree rotating tube
- 25 bar pressure resistant ceramic cartridge used
- G 3/8 M-10 25 bar pressure resistant steel braided flex used
- Box 12 pieces

FİYAT / PRICE

50592

1130.00

NEW

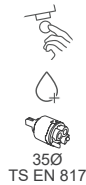

LAVABO BATARYASI

- Su tasarrufu özel aeratör (Köpük akış, kireç kırıcı, debi değeri: 8lt/dk)
- İdeal çalışma basıncı 3-4 Bar
- Ürünümsüz ms58/ms63 oranında alçak basınç pirinç külçeden üretilmiştir.
- Yüzeı kaplaması 0.3 mikron krom 7 mikron nikel kaplamadır.
- 25 bar basınca dayanıklı seramik kartuş kullanılmaktadır.
- 3/8 m-10 bar basınca dayanıklı çelik örgülü flex kullanılmıştır.



WASH BASIN FAUCET

- Water saving special aerator (foam flow, lime breaker, flow rate: 8lt / min)
- Ideal working pressure 3-4 Bar
- Our product is made of MS58/MS63 brass low pressure ingots
- Surface coating is 0.16 mm chrome coating
- 25 bar pressure resistant ceramic cartridge used
- G 3/8 M-10 25 bar pressure resistant steel braided flex used

FİYAT / PRICE

50593

1340.00

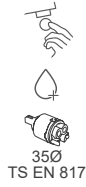
**BANYO BATARYASI**

- Ürünümsüz MS58/MS63 oranında alçak basınç pirinç külçeden üretilmiştir.
- Yüzey kaplaması 0.12 ile 0.16 mikron krom kaplamadır.
- 25 bar basınca dayanıklı seramik kartuş kullanılmaktadır.
- Tesisat bağlantıları G 1/2'dir.
- Koli içi 12 adet

**BATHROOM FAUCET**

- Our product is made of MS58/MS63 brass low pressure ingots
- Surface coating is 0.16 mm chrome coating
- 25 bar pressure resistant ceramic cartridge used
- Hand shower connections are G ½
- Box 12 pieces

FİYAT / PRICE

50490

1684.00

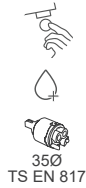
**APLİK EVİYE BATARYASI**

- Ürünümsüz MS58/MS63 oranında alçak basınç pirinç külçeden üretilmiştir.
- Yüzey kaplaması 0.12 ile 0.16 mikron krom kaplamadır.
- 25 bar basınca dayanıklı seramik kartuş kullanılmaktadır.
- Tesisat bağlantıları G 1/2'dir.
- Koli içi 12 adet

**KITCHEN FAUCET**

- Our product is made of MS58/MS63 brass low pressure ingots
- Surface coating is 0.16 mm chrome coating
- 25 bar pressure resistant ceramic cartridge used
- Hand shower connections are G ½
- Box 12 pieces

FİYAT / PRICE

50510

1380.00

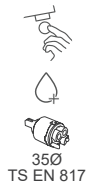
**KUĞU EVİYE BATARYASI**

- Su tasarrufu özel aeratör (Köpük akış, kireç kırıcı, debi değeri: 8lt/dk)
- İdeal çalışma basıncı 3-4 Bar
- Ürünümsüz ms58/ms63 oranında alçak basınç pirinç külçeden üretilmiştir.
- Yüzey kaplaması 0.3 mikron krom 7 mikron nikel kaplamadır.
- 360 derece döner boruludur
- 25 bar basınca dayanıklı seramik kartuş kullanılmaktadır.
- 3/8 m-10 bar basınca dayanıklı çelik örgülü flex kullanılmıştır.
- Koli içi 12 adet

**KITCHEN FAUCET**

- Water saving special aerator (foam flow, lime breaker, flow rate: 8lt / min)
- Ideal working pressure 3-4 Bar
- Our product is made of MS58/MS63 brass low pressure ingots
- Surface coating is 0.16 mm chrome coating
- 360 degree rotating tube
- 25 bar pressure resistant ceramic cartridge used
- G 3/8 M-10 25 bar pressure resistant steel braided flex used
- Box 12 pieces

FİYAT / PRICE

50492

1220.00

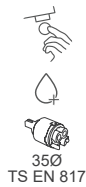
**LAVABO BATARYASI**

- Su tasarrufu özel aeratör (Köpük akış, kireç kırıcı, debi değeri: 8lt/dk)
- İdeal çalışma basıncı 3-4 Bar
- Ürünümsüz ms58/ms63 oranında alçak basınç pirinç külçeden üretilmiştir.
- Yüzey kaplaması 0.3 mikron krom 7 mikron nikel kaplamadır.
- 25 bar basınca dayanıklı seramik kartuş kullanılmaktadır.
- 3/8 m-10 bar basınca dayanıklı çelik örgülü flex kullanılmıştır.

**WASH BASIN FAUCET**

- Water saving special aerator (foam flow, lime breaker, flow rate: 8lt / min)
- Ideal working pressure 3-4 Bar
- Our product is made of MS58/MS63 brass low pressure ingots
- Surface coating is 0.16 mm chrome coating
- 25 bar pressure resistant ceramic cartridge used
- G 3/8 M-10 25 bar pressure resistant steel braided flex used

FİYAT / PRICE

50491

1560.00

LOFT GOLD

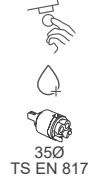

BANYO BATARYASI

- Ürünümsüz MS58/MS63 oranında alçak basınç pirinç külçeden üretilmiştir.
- Yüzey kaplaması 0.12 ile 0.16 mikron krom kaplamadır.
- 25 bar basınca dayanıklı seramik kartuş kullanılmaktadır.
- Tesisat bağlantıları G 1/2'dir.
- Koli içi 12 adet



BATHROOM FAUCET

- Our product is made of MS58/MS63 brass low pressure ingots
- Surface coating is 0.16 mm chrome coating
- 25 bar pressure resistant ceramic cartridge used
- Hand shower connections are G 1/2
- Box 12 pieces

FİYAT / PRICE

50503

2484.00

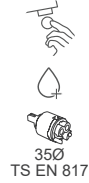

KUĞU EVİYE BATARYASI

- Su tasarrufu özel aeratör (Köpük akış, kireç kırıcı, debi değeri: 8lt/dk)
- İdeal çalışma basıncı 3-4 Bar
- Ürünümsüz ms58/ms63 oranında alçak basınç pirinç külçeden üretilmiştir.
- Yüzey kaplaması 0.3 mikron krom 7 mikron nikel kaplamadır.
- 360 derece döner boruludur
- 25 bar basınca dayanıklı seramik kartuş kullanılmaktadır.
- 3/8 m-10 bar basınca dayanıklı çelik örgülü flex kullanılmıştır.
- Koli içi 12 adet



KITCHEN FAUCET

- Water saving special aerator (foam flow, lime breaker, flow rate: 8lt / min)
- Ideal working pressure 3-4 Bar
- Our product is made of MS58/MS63 brass low pressure ingots
- Surface coating is 0.16 mm chrome coating
- 360 degree rotating tube
- 25 bar pressure resistant ceramic cartridge used
- G 3/8 M-10 25 bar pressure resistant steel braided flex used
- Box 12 pieces

FİYAT / PRICE

50504

2020.00



LAVABO BATARYASI

- Su tasarrufu özel aeratör (Köpük akış, kireç kırıcı, debi değeri: 8lt/dk)
- İdeal çalışma basıncı 3-4 Bar
- Ürünümsüz ms58/ms63 oranında alçak basınç pirinç külçeden üretilmiştir.
- Yüzey kaplaması 0.3 mikron krom 7 mikron nikel kaplamadır.
- 25 bar basınca dayanıklı seramik kartuş kullanılmaktadır.
- 3/8 m-10 bar basınca dayanıklı çelik örgülü flex kullanılmıştır.



WASH BASIN FAUCET

- Water saving special aerator (foam flow, lime breaker, flow rate: 8lt / min)
- Ideal working pressure 3-4 Bar
- Our product is made of MS58/MS63 brass low pressure ingots
- Surface coating is 0.16 mm chrome coating
- 25 bar pressure resistant ceramic cartridge used
- G 3/8 M-10 25 bar pressure resistant steel braided flex used

FİYAT / PRICE

50505

2360.00



LOFT BLACK



350
TS EN 817

BANYO BATARYASI

- Ürünümüz MS58/MS63 oranında alçak basınç pirinç külçeden üretilmiştir.
- Yüzey kaplaması 0.12 ile 0.16 mikron krom kaplamadır.
- 25 bar basınca dayanıklı seramik kartuş kullanılmaktadır.
- Tesisat bağlantıları G 1/2'dir.
- Koli içi 12 adet



BATHROOM FAUCET

- Our product is made of MS58/MS63 brass low pressure ingots
- Surface coating is 0.16 mm chrome coating
- 25 bar pressure resistant ceramic cartridge used
- Hand shower connections are G 1/2
- Box 12 pieces

FİYAT / PRICE

50506

2084.00



350
TS EN 817

KUĞU EVİYE BATARYASI

- Su tasarrufu özel aeratör (Köpük akış, kireç kırıcı, debi değeri: 8lt/dk)
- İdeal çalışma basıncı 3-4 Bar
- Ürünümüz ms58/ms63 oranında alçak basınç pirinç külçeden üretilmiştir.
- Yüzey kaplaması 0.3 mikron krom 7 mikron nikel kaplamadır.
- 360 derece döner boruludur
- 25 bar basınca dayanıklı seramik kartuş kullanılmaktadır.
- 3/8 m-10 bar basınca dayanıklı çelik örgülü flex kullanılmıştır.
- Koli içi 12 adet



KITCHEN FAUCET

- Water saving special aerator (foam flow, lime breaker, flow rate: 8lt / min)
- Ideal working pressure 3-4 Bar
- Our product is made of MS58/MS63 brass low pressure ingots
- Surface coating is 0.16 mm chrome coating
- 360 degree rotating tube
- 25 bar pressure resistant ceramic cartridge used
- G 3/8 M-10 25 bar pressure resistant steel braided flex used
- Box 12 pieces

FİYAT / PRICE

50507

1620.00



350
TS EN 817

LAVABO BATARYASI

- Su tasarrufu özel aeratör (Köpük akış, kireç kırıcı, debi değeri: 8lt/dk)
- İdeal çalışma basıncı 3-4 Bar
- Ürünümüz ms58/ms63 oranında alçak basınç pirinç külçeden üretilmiştir.
- Yüzey kaplaması 0.3 mikron krom 7 mikron nikel kaplamadır.
- 25 bar basınca dayanıklı seramik kartuş kullanılmaktadır.
- 3/8 m-10 bar basınca dayanıklı çelik örgülü flex kullanılmıştır.



WASH BASIN FAUCET

- Water saving special aerator (foam flow, lime breaker, flow rate: 8lt / min)
- Ideal working pressure 3-4 Bar
- Our product is made of MS58/MS63 brass low pressure ingots
- Surface coating is 0.16 mm chrome coating
- 25 bar pressure resistant ceramic cartridge used
- G 3/8 M-10 25 bar pressure resistant steel braided flex used

FİYAT / PRICE

50508

1960.00

POLO



BANYO BATARYASI

- Ürünümsüz MS58/MS63 oranında alçak basınç piriñç külçeden üretimiştir.
- Yüzey kaplaması 0.12 ile 0.16 mikron krom kaplamadır.
- 25 bar basınca dayanıklı seramik kartuş kullanılmaktadır.
- Tesisat bağlantıları G 1/2'dir.
- Koli içi 12 adet



BATHROOM FAUCET

- Our product is made of MS58/MS63 brass low pressure ingots
- Surface coating is 0.16 mm chrome coating
- 25 bar pressure resistant ceramic cartridge used
- Hand shower connections are G ½
- Box 12 pieces

KROM

50496

1962.00

SİYAH

50525

2362.00

GOLD

50569

2762.00

FİYAT / PRICE

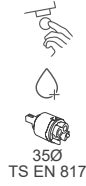

KUĞU EVİYE BATARYASI

- Su tasarrufu özel aeratör (Köpük akış, kireç kırıcı, debi değeri: 8lt/dk)
- İdeal çalışma basıncı 3-4 Bar
- Ürünümsüz ms58/ms63 oranında alçak basınç piriñç külçeden üretimiştir.
- Yüzey kaplaması 0.3 mikron krom 7 mikron nikel kaplamadır.
- 25 bar basınca dayanıklı seramik kartuş kullanılmaktadır.
- 3/8 m-10 bar basınca dayanıklı çelik örgülü flex kullanılmıştir.



KITCHEN FAUCET

- Water saving special aerator (foam flow, lime breaker, flow rate: 8lt / min)
- Ideal working pressure 3-4 Bar
- Our product is made of MS58/MS63 brass low pressure ingots
- Surface coating is 0.16 mm chrome coating
- 360 degree rotating tube
- 25 bar pressure resistant ceramic cartridge used
- G 3/8 M-10 25 bar pressure resistant steel braided flex used
- Box 12 pieces

KROM

50497

1108.00

SİYAH

50526

1508.00

GOLD

50570

1908.00

FİYAT / PRICE

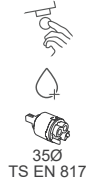

LAVABO BATARYASI

- Su tasarrufu özel aeratör (Köpük akış, kireç kırıcı, debi değeri: 8lt/dk)
- İdeal çalışma basıncı 3-4 Bar
- Ürünümsüz ms58/ms63 oranında alçak basınç piriñç külçeden üretimiştir.
- Yüzey kaplaması 0.3 mikron krom 7 mikron nikel kaplamadır.
- 360 derece döner boruludur
- 25 bar basınca dayanıklı seramik kartuş kullanılmaktadır.
- 3/8 m-10 bar basınca dayanıklı çelik örgülü flex kullanılmıştir.
- Koli içi 12 adet



WASH BASIN FAUCET

- Water saving special aerator (foam flow, lime breaker, flow rate: 8lt / min)
- Ideal working pressure 3-4 Bar
- Our product is made of MS58/MS63 brass low pressure ingots
- Surface coating is 0.16 mm chrome coating
- 360 degree rotating tube
- 25 bar pressure resistant ceramic cartridge used
- G 3/8 M-10 25 bar pressure resistant steel braided flex used
- Box 12 pieces

KROM

50498

1704.00

SİYAH

50527

2104.00

GOLD

50571

2504.00

FİYAT / PRICE



APLİK EVİYE BATARYASI

- Ürünümsüz MS58/MS63 oranında alçak basınç piriñç külçeden üretimiştir.
- Yüzey kaplaması 0.12 ile 0.16 mikron krom kaplamadır.
- 25 bar basınca dayanıklı seramik kartuş kullanılmaktadır.
- Tesisat bağlantıları G 1/2'dir.
- Koli içi 12 adet



KITCHEN FAUCET

- Our product is made of MS58/MS63 brass low pressure ingots
- Surface coating is 0.16 mm chrome coating
- 25 bar pressure resistant ceramic cartridge used
- Hand shower connections are G ½
- Box 12 pieces

KROM

50572

1486.00

FİYAT / PRICE



**BANYO BATARYASI**

- Ürünümsüz MS58/MS63 oranında alçak basınç pirinç külçeden üretilmiştir.
- Yüzey kaplaması 0.12 ile 0.16 mikron krom kaplamadır.
- 25 bar basınca dayanıklı seramik kartuş kullanılmaktadır.
- Tesisat bağlantıları G 1/2 dir.
- Koli içi 12 adet

**BATHROOM FAUCET**

- Our product is made of MS58/MS63 brass low pressure ingots
- Surface coating is 0.16 mm chrome coating
- 25 bar pressure resistant ceramic cartridge used
- Hand shower connections are G ½
- Box 12 pieces

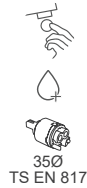
KROM**50487****1888.00****SİYAH****50560****2288.00****GOLD****50559****2688.00****FİYAT / PRICE****EVİYE BATARYASI**

- Su tasarrufu özel aeratör (Köpük akış. kireç kırıcı. debi değeri: 8lt/dk)
- İdeal çalışma basıncı 3-4 Bar
- Ürünümsüz ms58/ms63 oranında alçak basınç pirinç külçeden üretilmiştir.
- Yüzey kaplaması 0.3 mikron krom 7 mikron nikel kaplamadır.
- 360 derece döner boruludur
- 25 bar basınca dayanıklı seramik kartuş kullanılmaktadır.
- 3/8 m-10 bar basınca dayanıklı çelik örgülü flex kullanılmıştır.
- Koli içi 12 adet

**KITCHEN FAUCET**

- Water saving special aerator (foam flow. lime breaker. flow rate: 8lt / min)
- Ideal working pressure 3-4 Bar
- Our product is made of MS58/MS63 brass low pressure ingots
- Surface coating is 0.16 mm chrome coating
- 360 degree rotating tube
- 25 bar pressure resistant ceramic cartridge used
- G 3/8 M-10 25 bar pressure resistant steel braided flex used
- Box 12 pieces

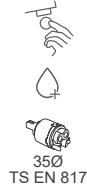
KROM**50493****1602.00****SİYAH****50566****2002.00****GOLD****50567****2402.00****FİYAT / PRICE****KUĞU LAVABO BATARYASI**

- Su tasarrufu özel aeratör (Köpük akış. kireç kırıcı. debi değeri: 8lt/dk)
- İdeal çalışma basıncı 3-4 Bar
- Ürünümsüz ms58/ms63 oranında alçak basınç pirinç külçeden üretilmiştir.
- Yüzey kaplaması 0.3 mikron krom 7 mikron nikel kaplamadır.
- 360 derece döner boruludur
- 25 bar basınca dayanıklı seramik kartuş kullanılmaktadır.
- 3/8 m-10 bar basınca dayanıklı çelik örgülü flex kullanılmıştır.

**WASH BASIN FAUCET**

- Water saving special aerator (foam flow. lime breaker. flow rate: 8lt / min)
- Ideal working pressure 3-4 Bar
- Our product is made of MS58/MS63 brass low pressure ingots
- Surface coating is 0.16 mm chrome coating
- 360 degree rotating tube
- 25 bar pressure resistant ceramic cartridge used
- G 3/8 M-10 25 bar pressure resistant steel braided flex used

KROM**50563****1602.00****SİYAH****50564****2002.00****GOLD****50565****2402.00****FİYAT / PRICE****LAVABO BATARYASI**

- Su tasarrufu özel aeratör (Köpük akış. kireç kırıcı. debi değeri: 8lt/dk)
- İdeal çalışma basıncı 3-4 Bar
- Ürünümsüz ms58/ms63 oranında alçak basınç pirinç külçeden üretilmiştir.
- Yüzey kaplaması 0.3 mikron krom 7 mikron nikel kaplamadır.
- 25 bar basınca dayanıklı seramik kartuş kullanılmaktadır.
- 3/8 m-10 bar basınca dayanıklı çelik örgülü flex kullanılmıştır.

**BASIN FAUCET**

- Water saving special aerator (foam flow. lime breaker. flow rate: 8lt / min)
- Ideal working pressure 3-4 Bar
- Our product is made of MS58/MS63 brass low pressure ingots
- Surface coating is 0.16 mm chrome coating
- 25 bar pressure resistant ceramic cartridge used
- G 3/8 M-10 25 bar pressure resistant steel braided flex used

KROM**50488****1944.00****SİYAH****50561****2344.00****GOLD****50562****2744.00****FİYAT / PRICE**

ELİTE



BANYO BATARYASI

- Ürünümüz MS58/MS63 oranında alçak basınç pirinç külçeden üretilmiştir.
- Yüzey kaplaması 0.12 ile 0.16 mikron krom kaplamadır.
- 25 bar basınca dayanıklı seramik kartuş kullanılmaktadır.
- Tesisat bağlantıları G 1/2'dir.
- Koli içi 12 adet



BATHROOM FAUCET

- Our product is made of MS58/MS63 brass low pressure ingots
- Surface coating is 0.16 mm chrome coating
- 25 bar pressure resistant ceramic cartridge used
- Hand shower connections are G ½
- Box 12 pieces

FİYAT / PRICE

50337

1846.00



KUĞU EVİYE BATARYASI

- Su tasarrufu özel aeratör (Köpük akış, kireç kırıcı, debi değeri: 8lt/dk)
- İdeal çalışma basıncı 3-4 Bar
- Ürünümüz ms58/ms63 oranında alçak basınç pirinç külçeden üretilmiştir.
- Yüzey kaplaması 0.3 mikron krom 7 mikron nikel kaplamadır.
- 360 derece döner boruludur
- 25 bar basınca dayanıklı seramik kartuş kullanılmaktadır.
- 3/8 m-10 bar basınca dayanıklı çelik örgülü flex kullanılmıştır.



KITCHEN FAUCET

- Water saving special aerator (foam flow, lime breaker, flow rate: 8lt / min)
- Ideal working pressure 3-4 Bar
- Our product is made of MS58/MS63 brass low pressure ingots
- Surface coating is 0.16 mm chrome coating
- 360 degree rotating tube
- 25 bar pressure resistant ceramic cartridge used
- G 3/8 M-10 25 bar pressure resistant steel braided flex used

FİYAT / PRICE

50509

974.00



KUĞU LAVABO BATARYASI

- Su tasarrufu özel aeratör (Köpük akış, kireç kırıcı, debi değeri: 8lt/dk)
- İdeal çalışma basıncı 3-4 Bar
- Ürünümüz ms58/ms63 oranında alçak basınç pirinç külçeden üretilmiştir.
- Yüzey kaplaması 0.3 mikron krom 7 mikron nikel kaplamadır.
- 360 derece döner boruludur
- 25 bar basınca dayanıklı seramik kartuş kullanılmaktadır.
- 3/8 m-10 bar basınca dayanıklı çelik örgülü flex kullanılmıştır.



WASH BASIN FAUCET

- Water saving special aerator (foam flow, lime breaker, flow rate: 8lt / min)
- Ideal working pressure 3-4 Bar
- Our product is made of MS58/MS63 brass low pressure ingots
- Surface coating is 0.16 mm chrome coating
- 360 degree rotating tube
- 25 bar pressure resistant ceramic cartridge used
- G 3/8 M-10 25 bar pressure resistant steel braided flex used

FİYAT / PRICE

50338

974.00



LAVABO BATARYASI

- Su tasarrufu özel aeratör (Köpük akış, kireç kırıcı, debi değeri: 8lt/dk)
- İdeal çalışma basıncı 3-4 Bar
- Ürünümüz ms58/ms63 oranında alçak basınç pirinç külçeden üretilmiştir.
- Yüzey kaplaması 0.3 mikron krom 7 mikron nikel kaplamadır.
- 25 bar basınca dayanıklı seramik kartuş kullanılmaktadır.
- 3/8 m-10 bar basınca dayanıklı çelik örgülü flex kullanılmıştır.
- 3/8 m-10 bar basınca dayanıklı çelik örgülü flex kullanılmıştır.



WASH BASIN FAUCET

- Water saving special aerator (foam flow, lime breaker, flow rate: 8lt / min)
- Ideal working pressure 3-4 Bar
- Our product is made of MS58/MS63 brass low pressure ingots
- Surface coating is 0.16 mm chrome coating
- 25 bar pressure resistant ceramic cartridge used
- G 3/8 M-10 25 bar pressure resistant steel braided flex used
- G 3/8 M-10 25 bar pressure resistant steel braided flex used

FİYAT / PRICE

50339

1506.00



35Ø
TS EN 817

BANYO BATARYASI

- Ürünümüz MS58/MS63 oranında alçak basınç pirinç külçeden üretilmiştir.
- Yüze kaplaması 0.12 ile 0.16 mikron krom kaplamadır.
- 25 bar basınca dayanıklı seramik kartuş kullanılmaktadır.
- Tesisat bağlantıları G 1/2'dir.
- Koli içi 12 adet



BATHROOM FAUCET

- Our product is made of MS58/MS53 brass low pressure ingots
- Surface coating is 0.16 mm chrome coating
- 25 bar pressure resistant ceramic cartridge used
- Hand shower connections are G ½
- Box 12 pieces

FİYAT / PRICE

50478

1650.00



35Ø
TS EN 817

KUĞU EVİYE BATARYASI

- Su tasarrufu özel aeratör (Köpük akış, kireç kırıcı, debi değeri: 8lt/dk)
- İdeal çalışma basıncı 3-4 Bar
- Ürünümüz ms58/ms63 oranında alçak basınç pirinç külçeden üretilmiştir.
- Yüze kaplaması 0.3 mikron krom 7 mikron nikel kaplamadır.
- 360 derece döner boruludur
- 25 bar basınca dayanıklı seramik kartuş kullanılmaktadır.
- 3/8 m-10 bar basınca dayanıklı çelik örgülü flex kullanılmıştır.



KITCHEN FAUCET

- Water saving special aerator (foam flow, lime breaker, flow rate: 8lt / min)
- Ideal working pressure 3-4 Bar
- Our product is made of MS58/MS63 brass low pressure ingots
- Surface coating is 0.16 mm chrome coating
- 360 degree rotating tube
- 25 bar pressure resistant ceramic cartridge used
- G 3/8 M-10 25 bar pressure resistant steel braided flex used

FİYAT / PRICE

50513

1108.00



35Ø
TS EN 817

LAVABO BATARYASI

- Su tasarrufu özel aeratör (Köpük akış, kireç kırıcı, debi değeri: 8lt/dk)
- İdeal çalışma basıncı 3-4 Bar
- Ürünümüz ms58/ms63 oranında alçak basınç pirinç külçeden üretilmiştir.
- Yüze kaplaması 0.3 mikron krom 7 mikron nikel kaplamadır.
- 25 bar basınca dayanıklı seramik kartuş kullanılmaktadır.
- 3/8 m-10 bar basınca dayanıklı çelik örgülü flex kullanılmıştır.
- 3/8 m-10 bar basınca dayanıklı çelik örgülü flex kullanılmıştır.



WASH BASIN FAUCET

- Water saving special aerator (foam flow, lime breaker, flow rate: 8lt / min)
- Ideal working pressure 3-4 Bar
- Our product is made of MS58/MS63 brass low pressure ingots
- Surface coating is 0.16 mm chrome coating
- 25 bar pressure resistant ceramic cartridge used
- G 3/8 M-10 25 bar pressure resistant steel braided flex used
- G 3/8 M-10 25 bar pressure resistant steel braided flex used

FİYAT / PRICE

50480

1470.00



35Ø
TS EN 817

APLİK EVİYE BATARYASI

- Ürünümüz MS58/MS63 oranında alçak basınç pirinç külçeden üretilmiştir.
- Yüze kaplaması 0.12 ile 0.16 mikron krom kaplamadır.
- 25 bar basınca dayanıklı seramik kartuş kullanılmaktadır.
- Tesisat bağlantıları G 1/2'dir.
- Koli içi 12 adet



KITCHEN FAUCET

- Our product is made of MS58/MS53 brass low pressure ingots
- Surface coating is 0.16 mm chrome coating
- 25 bar pressure resistant ceramic cartridge used
- Hand shower connections are G ½
- Box 12 pieces

FİYAT / PRICE

50517

1422.00

MARS GOLD

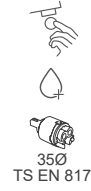

BANYO BATARYASI

- Ürünüümüz MS58/MS63 oranında alçak basınç pirinç külçeden üretilmiştir.
- Yüzey kaplaması 0.12 ile 0.16 mikron krom kaplamadır.
- 25 bar basınca dayanıklı seramik kartuş kullanılmaktadır.
- Tesisat bağlantıları G 1/2'dir.
- Koli içi 12 adet



BATHROOM FAUCET

- Our product is made of MS58/MS63 brass low pressure ingots
- Surface coating is 0.16 mm chrome coating
- 25 bar pressure resistant ceramic cartridge used
- Hand shower connections are G 1/2
- Box 12 pieces

FİYAT / PRICE

50482

2450.00

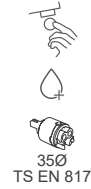

KUĞU EVİYE BATARYASI

- Su tasarrufu özel aeratör (Köpük akış, kireç kırıcı, debi değeri: 8lt/dk)
- İdeal çalışma basıncı 3-4 Bar
- Ürünüümüz ms58/ms63 oranında alçak basınç pirinç külçeden üretilmiştir.
- Yüzey kaplaması 0.3 mikron krom 7 mikron nikel kaplamadır.
- 360 derece döner boruludur
- 25 bar basınca dayanıklı seramik kartuş kullanılmaktadır.
- 3/8 m-10 bar basınca dayanıklı çelik örgülü flex kullanılmıştır.



KITCHEN FAUCET

- Water saving special aerator (foam flow, lime breaker, flow rate: 8lt / min)
- Ideal working pressure 3-4 Bar
- Our product is made of MS58/MS63 brass low pressure ingots
- Surface coating is 0.16 mm chrome coating
- 360 degree rotating tube
- 25 bar pressure resistant ceramic cartridge used
- G 3/8 M-10 25 bar pressure resistant steel braided flex used

FİYAT / PRICE

50514

1908.00



LAVABO BATARYASI

- Su tasarrufu özel aeratör (Köpük akış, kireç kırıcı, debi değeri: 8lt/dk)
- İdeal çalışma basıncı 3-4 Bar
- Ürünüümüz ms58/ms63 oranında alçak basınç pirinç külçeden üretilmiştir.
- Yüzey kaplaması 0.3 mikron krom 7 mikron nikel kaplamadır.
- 25 bar basınca dayanıklı seramik kartuş kullanılmaktadır.
- 3/8 m-10 bar basınca dayanıklı çelik örgülü flex kullanılmıştır.
- 3/8 m-10 bar basınca dayanıklı çelik örgülü flex kullanılmıştır.



WASH BASIN FAUCET

- Water saving special aerator (foam flow, lime breaker, flow rate: 8lt / min)
- Ideal working pressure 3-4 Bar
- Our product is made of MS58/MS63 brass low pressure ingots
- Surface coating is 0.16 mm chrome coating
- 25 bar pressure resistant ceramic cartridge used
- G 3/8 M-10 25 bar pressure resistant steel braided flex used
- G 3/8 M-10 25 bar pressure resistant steel braided flex used

FİYAT / PRICE

50484

2270.00

HERA

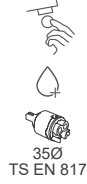

BANYO BATARYASI

- Ürünümsüz MS58/MS63 oranında alçak basınç piriñ külçeden üretiştir.
- Yüzey kaplaması 0.12 ile 0.16 mikron krom kaplamadır.
- 25 bar basınca dayanıklı seramik kartuş kullanılmaktadır.
- Tesisat bağlantıları G 1/2 dir.
- Koli içi 12 adet



50343

FİYAT / PRICE

1716.00



EVİYE BATARYASI

- Su tasarrufu özel aeratör (Köpük akış. kireç kırıcı. debi değeri: 8lt/dk)
- İdeal çalışma basıncı 3-4 Bar
- Ürünümsüz ms58/ms63 oranında alçak basınç piriñ külçeden üretiştir.
- Yüzey kaplaması 0.3 mikron krom 7 mikron nikel kaplamadır.
- 360 derece döner boruludur
- 25 bar basınca dayanıklı seramik kartuş kullanılmaktadır.
- 3/8 m-10 bar basınca dayanıklı çelik örgülü flex kullanılmıştir.



50344

FİYAT / PRICE

2652.00

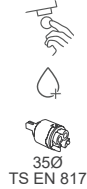

LAVABO BATARYASI

- Su tasarrufu özel aeratör (Köpük akış. kireç kırıcı. debi değeri: 8lt/dk)
- İdeal çalışma basıncı 3-4 Bar
- Ürünümsüz ms58/ms63 oranında alçak basınç piriñ külçeden üretiştir.
- Yüzey kaplaması 0.3 mikron krom 7 mikron nikel kaplamadır.
- 25 bar basınca dayanıklı seramik kartuş kullanılmaktadır.
- 3/8 m-10 bar basınca dayanıklı çelik örgülü flex kullanılmıştir.
- 3/8 m-10 bar basınca dayanıklı çelik örgülü flex kullanılmıştir.



50345

FİYAT / PRICE

1464.00



APLIK EVİYE BATARYASI

- Su tasarrufu özel aeratör (Köpük akış. kireç kırıcı. debi değeri: 8lt/dk)
- İdeal çalışma basıncı 3-4 Bar
- Ürünümsüz ms58/ms63 oranında alçak basınç piriñ külçeden üretiştir.
- Yüzey kaplaması 0.3 mikron krom 7 mikron nikel kaplamadır.
- 360 derece döner boruludur
- 25 bar basınca dayanıklı seramik kartuş kullanılmaktadır.
- 3/8 m-10 bar basınca dayanıklı çelik örgülü flex kullanılmıştir.



50316

FİYAT / PRICE

1282.00

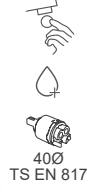

40Ø
TS EN 817

BANYO BATARYASI

- Ürünümüz MS58/MS63 oranında alçak basınç pirinç külçeden üretilmiştir.
- Yüzey kaplaması 0.12 ile 0.16 mikron krom kaplamadır.
- 25 bar basınca dayanıklı seramik kartuş kullanılmaktadır.
- Tesisat bağlantıları G 1/2'dir.
- Koli içi 12 adet



BATHROOM FAUCET

- Our product is made of MS58/MS63 brass low pressure ingots
- Surface coating is 0.16 mm chrome coating
- 25 bar pressure resistant ceramic cartridge used
- Hand shower connections are G ½
- Box 12 pieces

FİYAT / PRICE

50069

1346.00

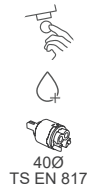

40Ø
TS EN 817

KUĞU EVİYE BATARYASI

- Su tasarrufu özel aeratör (Köpük akış, kireç kırıcı, debi değeri: 8lt/dk)
- İdeal çalışma basıncı 3-4 Bar
- Ürünümüz ms58/ms63 oranında alçak basınç pirinç külçeden üretilmiştir.
- Yüzey kaplaması 0.3 mikron krom 7 mikron nikel kaplamadır.
- 360 derece döner boruludur
- 25 bar basınca dayanıklı seramik kartuş kullanılmaktadır.
- 3/8 m-10 bar basınca dayanıklı çelik örgülü flex kullanılmıştır.



KITCHEN FAUCET

- Water saving special aerator (foam flow, lime breaker, flow rate: 8lt / min)
- Ideal working pressure 3-4 Bar
- Our product is made of MS58/MS63 brass low pressure ingots
- Surface coating is 0.16 mm chrome coating
- 360 degree rotating tube
- 25 bar pressure resistant ceramic cartridge used
- G 3/8 M-10 25 bar pressure resistant steel braided flex used

KUĞU EVİYE

50067

704.00

KUĞU LAVABO

50068

704.00

FİYAT / PRICE

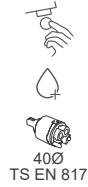

40Ø
TS EN 817

Boru Ø 28 hareketli perlatör

LUX EVİYE BATARYASI

- Su tasarrufu özel aeratör (Köpük akış, kireç kırıcı, debi değeri: 8lt/dk)
- İdeal çalışma basıncı 3-4 Bar
- Ürünümüz ms58/ms63 oranında alçak basınç pirinç külçeden üretilmiştir.
- Yüzey kaplaması 0.3 mikron krom 7 mikron nikel kaplamadır.
- 360 derece döner boruludur
- 25 bar basınca dayanıklı seramik kartuş kullanılmaktadır.
- 3/8 m-10 bar basınca dayanıklı çelik örgülü flex kullanılmıştır.



KITCHEN FAUCET

- Water saving special aerator (foam flow, lime breaker, flow rate: 8lt / min)
- Ideal working pressure 3-4 Bar
- Our product is made of MS58/MS63 brass low pressure ingots
- Surface coating is 0.16 mm chrome coating
- 360 degree rotating tube
- 25 bar pressure resistant ceramic cartridge used
- G 3/8 M-10 25 bar pressure resistant steel braided flex used

50441

FİYAT / PRICE

1000.00



40Ø
TS EN 817

LAVABO BATARYASI

- Su tasarrufu özel aeratör (Köpük akış, kireç kırıcı, debi değeri: 8lt/dk)
- İdeal çalışma basıncı 3-4 Bar
- Ürünümüz ms58/ms63 oranında alçak basınç pirinç külçeden üretilmiştir.
- Yüzey kaplaması 0.3 mikron krom 7 mikron nikel kaplamadır.
- 25 bar basınca dayanıklı seramik kartuş kullanılmaktadır.
- 3/8 m-10 bar basınca dayanıklı çelik örgülü flex kullanılmıştır.
- 3/8 m-10 bar basınca dayanıklı çelik örgülü flex kullanılmıştır.



WASH BASIN FAUCET

- Water saving special aerator (foam flow, lime breaker, flow rate: 8lt / min)
- Ideal working pressure 3-4 Bar
- Our product is made of MS58/MS63 brass low pressure ingots
- Surface coating is 0.16 mm chrome coating
- 25 bar pressure resistant ceramic cartridge used
- G 3/8 M-10 25 bar pressure resistant steel braided flex used
- G 3/8 M-10 25 bar pressure resistant steel braided flex used

50070

FİYAT / PRICE

1432.00

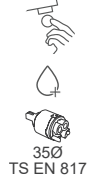

BANYO BATARYASI

- Ürünümsüz MS58/MS63 oranında alçak basınç pirinç külçeden üretilmiştir.
- Yüzey kaplaması 0.12 ile 0.16 mikron krom kaplamadır.
- 25 bar basınca dayanıklı seramik kartuş kullanılmaktadır.
- Tesisat bağlantıları G 1/2'dir.
- Koli içi 12 adet



BATHROOM FAUCET

- Our product is made of MS58/MS63 brass low pressure ingots
- Surface coating is 0.16 mm chrome coating
- 25 bar pressure resistant ceramic cartridge used
- Hand shower connections are G ½
- Box 12 pieces

FIYAT / PRICE

50340

1722.00



KUĞU EVİYE BATARYASI

- Su tasarrufu özel aeratör (Köpük akış, kireç kırıcı, debi değeri: 8lt/dk)
- İdeal çalışma basıncı 3-4 Bar
- Ürünümsüz ms58/ms63 oranında alçak basınç pirinç külçeden üretilmiştir.
- Yüzey kaplaması 0.3 mikron krom 7 mikron nikel kaplamadır.
- 360 derece döner boruludur
- 25 bar basınca dayanıklı seramik kartuş kullanılmaktadır.
- 3/8 m-10 bar basınca dayanıklı çelik örgülü flex kullanılmıştır.



KITCHEN FAUCET

- Water saving special aerator (foam flow, lime breaker, flow rate: 8lt / min)
- Ideal working pressure 3-4 Bar
- Our product is made of MS58/MS63 brass low pressure ingots
- Surface coating is 0.16 mm chrome coating
- 360 degree rotating tube
- 25 bar pressure resistant ceramic cartridge used
- G 3/8 M-10 25 bar pressure resistant steel braided flex used

FIYAT / PRICE

50341

950.00



KUĞU VİP EVİYE BATARYASI

- Su tasarrufu özel aeratör (Köpük akış, kireç kırıcı, debi değeri: 8lt/dk)
- İdeal çalışma basıncı 3-4 Bar
- Ürünümsüz ms58/ms63 oranında alçak basınç pirinç külçeden üretilmiştir.
- Yüzey kaplaması 0.3 mikron krom 7 mikron nikel kaplamadır.
- 360 derece döner boruludur
- 25 bar basınca dayanıklı seramik kartuş kullanılmaktadır.
- 3/8 m-10 bar basınca dayanıklı çelik örgülü flex kullanılmıştır.
- Koli içi 12 adet



KITCHEN FAUCET

- Water saving special aerator (foam flow, lime breaker, flow rate: 8lt / min)
- Ideal working pressure 3-4 Bar
- Our product is made of MS58/MS63 brass low pressure ingots
- Surface coating is 0.16 mm chrome coating
- 360 degree rotating tube
- 25 bar pressure resistant ceramic cartridge used
- G 3/8 M-10 25 bar pressure resistant steel braided flex used
- Box 12 pieces

FIYAT / PRICE

50439

974.00



LAVABO BATARYASI

- Su tasarrufu özel aeratör (Köpük akış, kireç kırıcı, debi değeri: 8lt/dk)
- İdeal çalışma basıncı 3-4 Bar
- Ürünümsüz ms58/ms63 oranında alçak basınç pirinç külçeden üretilmiştir.
- Yüzey kaplaması 0.3 mikron krom 7 mikron nikel kaplamadır.
- 25 bar basınca dayanıklı seramik kartuş kullanılmaktadır.
- 3/8 m-10 bar basınca dayanıklı çelik örgülü flex kullanılmıştır.
- 3/8 m-10 bar basınca dayanıklı çelik örgülü flex kullanılmıştır.



WASH BASIN FAUCET

- Water saving special aerator (foam flow, lime breaker, flow rate: 8lt / min)
- Ideal working pressure 3-4 Bar
- Our product is made of MS58/MS63 brass low pressure ingots
- Surface coating is 0.16 mm chrome coating
- 25 bar pressure resistant ceramic cartridge used
- G 3/8 M-10 25 bar pressure resistant steel braided flex used
- G 3/8 M-10 25 bar pressure resistant steel braided flex used

FIYAT / PRICE

50342

1382.00

KARE



BANYO BATARYASI

- Ürünüümüz MS58/MS63 oranında alçak basınç pirinç külçeden üretilmiştir.
- Yüze kaplaması 0.12 ile 0.16 mikron krom kaplamadır.
- 25 bar basınca dayanıklı seramik kartuş kullanılmaktadır.
- Tesisat bağlantıları G 1/2'dir.
- Koli içi 12 adet



BATHROOM FAUCET

- Our product is made of MS58/MS63 brass low pressure ingots
- Surface coating is 0.16 mm chrome coating
- 25 bar pressure resistant ceramic cartridge used
- Hand shower connections are G ½
- Box 12 pieces

FİYAT / PRICE

50051

2026.00



LAVABO BATARYASI

- Su tasarrufu özel aeratör (Köpük akış, kireç kırıcı, debi değeri: 8lt/dk)
- İdeal çalışma basıncı 3-4 Bar
- Ürünüümüz ms58/ms63 oranında alçak basınç pirinç külçeden üretilmiştir.
- Yüze kaplaması 0.3 mikron krom 7 mikron nikel kaplamadır.
- 25 bar basınca dayanıklı seramik kartuş kullanılmaktadır.
- 3/8 m-10 bar basınca dayanıklı çelik örgülü flex kullanılmıştır.
- 3/8 m-10 bar basınca dayanıklı çelik örgülü flex kullanılmıştır.



WASH BASIN FAUCET

- Water saving special aerator (foam flow, lime breaker, flow rate: 8lt / min)
- Ideal working pressure 3-4 Bar
- Our product is made of MS58/MS63 brass low pressure ingots
- Surface coating is 0.16 mm chrome coating
- 25 bar pressure resistant ceramic cartridge used
- G 3/8 M-10 25 bar pressure resistant steel braided flex used
- G 3/8 M-10 25 bar pressure resistant steel braided flex used

FİYAT / PRICE

50256

1602.00



KUĞU EVİYE BATARYASI

- Su tasarrufu özel aeratör (Köpük akış, kireç kırıcı, debi değeri: 8lt/dk)
- İdeal çalışma basıncı 3-4 Bar
- Ürünüümüz ms58/ms63 oranında alçak basınç pirinç külçeden üretilmiştir.
- Yüze kaplaması 0.3 mikron krom 7 mikron nikel kaplamadır.
- 360 derece döner boruludur
- 25 bar basınca dayanıklı seramik kartuş kullanılmaktadır.
- 3/8 m-10 bar basınca dayanıklı çelik örgülü flex kullanılmıştır.



KITCHEN FAUCET

- Water saving special aerator (foam flow, lime breaker, flow rate: 8lt / min)
- Ideal working pressure 3-4 Bar
- Our product is made of MS58/MS63 brass low pressure ingots
- Surface coating is 0.16 mm chrome coating
- 360 degree rotating tube
- 25 bar pressure resistant ceramic cartridge used
- G 3/8 M-10 25 bar pressure resistant steel braided flex used

FİYAT / PRICE

50052

1602.00

**APLIK EVİYE BATARYASI**

- Su tasarrufu özel aeratör (Köpük akış, kireç kırıcı, debi değeri: 8lt/dk)
- İdeal çalışma basıncı 3-4 Bar
- Ürünümsüz ms58/ms63 oranında alçak basınç pirinç külçeden üretilmiştir.
- Yüzey kaplaması 0.3 mikron krom 7 mikron nikel kaplamadır.
- 360 derece döner boruludur
- 25 bar basınca dayanıklı seramik kartuş kullanılmaktadır.
- 3/8 m-10 bar basınca dayanıklı çelik örgülü flex kullanılmıştır.

KITCHEN FAUCET

- Water saving special aerator (foam flow, lime breaker, flow rate: 8lt / min)
- Ideal working pressure 3-4 Bar
- Our product is made of MS58/MS63 brass low pressure ingots
- Surface coating is 0.16 mm chrome coating
- 360 degree rotating tube
- 25 bar pressure resistant ceramic cartridge used
- G 3/8 M-10 25 bar pressure resistant steel braided flex used



FİYAT / PRICE

50206**1884.00****LAVABO BATARYASI**

- Su tasarrufu özel aeratör (Köpük akış, kireç kırıcı, debi değeri: 8lt/dk)
- İdeal çalışma basıncı 3-4 Bar
- Ürünümsüz ms58/ms63 oranında alçak basınç pirinç külçeden üretilmiştir.
- Yüzey kaplaması 0.3 mikron krom 7 mikron nikel kaplamadır.
- 25 bar basınca dayanıklı seramik kartuş kullanılmaktadır.
- 3/8 m-10 bar basınca dayanıklı çelik örgülü flex kullanılmıştır.
- 3/8 m-10 bar basınca dayanıklı çelik örgülü flex kullanılmıştır.

WASH BASIN FAUCET

- Water saving special aerator (foam flow, lime breaker, flow rate: 8lt / min)
- Ideal working pressure 3-4 Bar
- Our product is made of MS58/MS63 brass low pressure ingots
- Surface coating is 0.16 mm chrome coating
- 25 bar pressure resistant ceramic cartridge used
- G 3/8 M-10 25 bar pressure resistant steel braided flex used
- G 3/8 M-10 25 bar pressure resistant steel braided flex used



FİYAT / PRICE

50053**1776.00****ŞATTAFF BATARYASI SETİ**

- Su tasarrufu özel aeratör (Köpük akış, kireç kırıcı, debi değeri: 8lt/dk)
- İdeal çalışma basıncı 3-4 Bar
- Ürünümsüz ms58/ms63 oranında alçak basınç pirinç külçeden üretilmiştir.
- Yüzey kaplaması 0.3 mikron krom 7 mikron nikel kaplamadır.
- 25 bar basınca dayanıklı seramik kartuş kullanılmaktadır.
- 3/8 m-10 bar basınca dayanıklı çelik örgülü flex kullanılmıştır.
- Koli içi 12 adet

SHUT-OFF FAUCET

- Water saving special aerator (foam flow, lime breaker, flow rate: 8lt / min)
- Ideal working pressure 3-4 Bar
- Our product is made of MS58/MS63 brass low pressure ingots
- Surface coating is 0.16 mm chrome coating
- 25 bar pressure resistant ceramic cartridge used
- G 3/8 M-10 25 bar pressure resistant steel braided flex used
- Box 12 pieces

**ŞATTAFSIZ****50207****1818.00****ŞATTAFLI****50205**

FİYAT / PRICE

1968.00

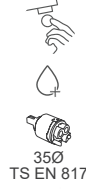

BANYO BATARYASI

- Ürünümsüz MS58/MS63 oranında alçak basınç pirinç külçeden üretilmiştir.
- Yüzey kaplaması 0.12 ile 0.16 mikron krom kaplamadır.
- 25 bar basınca dayanıklı seramik kartuş kullanılmaktadır.
- Tesisat bağlantıları G 1/2'dir.
- Koli içi 12 adet



BATHROOM FAUCET

- Our product is made of MS58/MS63 brass low pressure ingots
- Surface coating is 0.16 mm chrome coating
- 25 bar pressure resistant ceramic cartridge used
- Hand shower connections are G 1/2
- Box 12 pieces

FİYAT / PRICE

50047

1490.00



KUĞU EVİYE BATARYASI

- Su tasarrufu özel aeratör (Köpük akış, kireç kırıcı, debi değeri: 8lt/dk)
- İdeal çalışma basıncı 3-4 Bar
- Ürünümsüz ms58/ms63 oranında alçak basınç pirinç külçeden üretilmiştir.
- Yüzey kaplaması 0.3 mikron krom 7 mikron nikel kaplamadır.
- 360 derece döner boruludur
- 25 bar basınca dayanıklı seramik kartuş kullanılmaktadır.
- 3/8 m-10 bar basınca dayanıklı çelik örgülü flex kullanılmıştır.



KITCHEN FAUCET

- Water saving special aerator (foam flow, lime breaker, flow rate: 8lt / min)
- Ideal working pressure 3-4 Bar
- Our product is made of MS58/MS63 brass low pressure ingots
- Surface coating is 0.16 mm chrome coating
- 360 degree rotating tube
- 25 bar pressure resistant ceramic cartridge used
- G 3/8 M-10 25 bar pressure resistant steel braided flex used

FİYAT / PRICE

50049

912.00



KUĞU LAVABO BATARYASI

- Su tasarrufu özel aeratör (Köpük akış, kireç kırıcı, debi değeri: 8lt/dk)
- İdeal çalışma basıncı 3-4 Bar
- Ürünümsüz ms58/ms63 oranında alçak basınç pirinç külçeden üretilmiştir.
- Yüzey kaplaması 0.3 mikron krom 7 mikron nikel kaplamadır.
- 360 derece döner boruludur
- 25 bar basınca dayanıklı seramik kartuş kullanılmaktadır.
- 3/8 m-10 bar basınca dayanıklı çelik örgülü flex kullanılmıştır.



WASH BASIN FAUCET

- Water saving special aerator (foam flow, lime breaker, flow rate: 8lt / min)
- Ideal working pressure 3-4 Bar
- Our product is made of MS58/MS63 brass low pressure ingots
- Surface coating is 0.16 mm chrome coating
- 360 degree rotating tube
- 25 bar pressure resistant ceramic cartridge used
- G 3/8 M-10 25 bar pressure resistant steel braided flex used

FİYAT / PRICE

50048

912.00

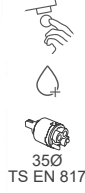

LAVABO BATARYASI

- Su tasarrufu özel aeratör (Köpük akış, kireç kırıcı, debi değeri: 8lt/dk)
- İdeal çalışma basıncı 3-4 Bar
- Ürünümüz ms58/ms63 oranında alçak basınç pirinç külçeden üretilmiştir.
- Yüzey kaplaması 0.3 mikron krom 7 mikron nikel kaplamadır.
- 25 bar basınca dayanıklı seramik kartuş kullanılmaktadır.
- 3/8 m-10 bar basınca dayanıklı çelik örgülü flex kullanılmıştır.
- 3/8 m-10 bar basınca dayanıklı çelik örgülü flex kullanılmıştır.



WASH BASIN FAUCET

- Water saving special aerator (foam flow, lime breaker, flow rate: 8lt / min)
- Ideal working pressure 3-4 Bar
- Our product is made of MS58/MS63 brass low pressure ingots
- Surface coating is 0.16 mm chrome coating
- 25 bar pressure resistant ceramic cartridge used
- G 3/8 M-10 25 bar pressure resistant steel braided flex used
- G 3/8 M-10 25 bar pressure resistant steel braided flex used

FİYAT / PRICE

50050

1372.00



APLIK EVİYE BATARYASI

- Su tasarrufu özel aeratör (Köpük akış, kireç kırıcı, debi değeri: 8lt/dk)
- İdeal çalışma basıncı 3-4 Bar
- Ürünümüz ms58/ms63 oranında alçak basınç pirinç külçeden üretilmiştir.
- Yüzey kaplaması 0.3 mikron krom 7 mikron nikel kaplamadır.
- 360 derece döner boruludur
- 25 bar basınca dayanıklı seramik kartuş kullanılmaktadır.
- 3/8 m-10 bar basınca dayanıklı çelik örgülü flex kullanılmıştır.



KITCHEN FAUCET

- Water saving special aerator (foam flow, lime breaker, flow rate: 8lt / min)
- Ideal working pressure 3-4 Bar
- Our product is made of MS58/MS63 brass low pressure ingots
- Surface coating is 0.16 mm chrome coating
- 360 degree rotating tube
- 25 bar pressure resistant ceramic cartridge used
- G 3/8 M-10 25 bar pressure resistant steel braided flex used

FİYAT / PRICE

50279

1266.00



hareketli perlatör



KUŞU EVİYE BATARYASI

- Su tasarrufu özel aeratör (Köpük akış, kireç kırıcı, debi değeri: 8lt/dk)
- İdeal çalışma basıncı 3-4 Bar
- Ürünümüz ms58/ms63 oranında alçak basınç pirinç külçeden üretilmiştir.
- Yüzey kaplaması 0.3 mikron krom 7 mikron nikel kaplamadır.
- 360 derece döner boruludur
- 25 bar basınca dayanıklı seramik kartuş kullanılmaktadır.
- 3/8 m-10 bar basınca dayanıklı çelik örgülü flex kullanılmıştır.



KITCHEN FAUCET

- Water saving special aerator (foam flow, lime breaker, flow rate: 8lt / min)
- Ideal working pressure 3-4 Bar
- Our product is made of MS58/MS63 brass low pressure ingots
- Surface coating is 0.16 mm chrome coating
- 360 degree rotating tube
- 25 bar pressure resistant ceramic cartridge used
- G 3/8 M-10 25 bar pressure resistant steel braided flex used

FİYAT / PRICE

50391

982.00

LARA



BANYO BATARYASI

- Ürünümsüz MS58/MS63 oranında alçak basınç piriñ külçeden üretiştir.
- Yüzey kaplaması 0.12 ile 0.16 mikron krom kaplamadır.
- 25 bar basınca dayanıklı seramik kartuş kullanılmaktadır.
- Tesisat bađlantıları G 1/2'dir.
- Koli içi 12 adet



BATHROOM FAUCET

- Our product is made of MS58/MS63 brass low pressure ingots
- Surface coating is 0.16 mm chrome coating
- 25 bar pressure resistant ceramic cartridge used
- Hand shower connections are G 1/2
- Box 12 pieces

FİYAT / PRICE

50382

1430.00

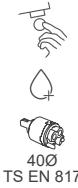

KUĐU EVİYE BATARYASI

- Su tasarrufu özel aeratör (Köpük akış, kireç kırıcı, debi değeri: 8lt/dk)
- İdeal çalışma basıncı 3-4 Bar
- Ürünümsüz ms58/ms63 oranında alçak basınç piriñ külçeden üretiştir.
- Yüzey kaplaması 0.3 mikron krom 7 mikron nikel kaplamadır.
- 360 derece döner boruludur
- 25 bar basınca dayanıklı seramik kartuş kullanılmaktadır.
- 3/8 m-10 bar basınca dayanıklı çelik örgülü flex kullanılmıştir.



KITCHEN FAUCET

- Water saving special aerator (foam flow, lime breaker, flow rate: 8lt / min)
- Ideal working pressure 3-4 Bar
- Our product is made of MS58/MS63 brass low pressure ingots
- Surface coating is 0.16 mm chrome coating
- 360 degree rotating tube
- 25 bar pressure resistant ceramic cartridge used
- G 3/8 M-10 25 bar pressure resistant steel braided flex used

FİYAT / PRICE

50385

928.00

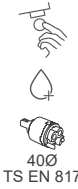

KUĐU LAVABO BATARYASI

- Su tasarrufu özel aeratör (Köpük akış, kireç kırıcı, debi değeri: 8lt/dk)
- İdeal çalışma basıncı 3-4 Bar
- Ürünümsüz ms58/ms63 oranında alçak basınç piriñ külçeden üretiştir.
- Yüzey kaplaması 0.3 mikron krom 7 mikron nikel kaplamadır.
- 360 derece döner boruludur
- 25 bar basınca dayanıklı seramik kartuş kullanılmaktadır.
- 3/8 m-10 bar basınca dayanıklı çelik örgülü flex kullanılmıştir.



WASH BASIN FAUCET

- Water saving special aerator (foam flow, lime breaker, flow rate: 8lt / min)
- Ideal working pressure 3-4 Bar
- Our product is made of MS58/MS63 brass low pressure ingots
- Surface coating is 0.16 mm chrome coating
- 360 degree rotating tube
- 25 bar pressure resistant ceramic cartridge used
- G 3/8 M-10 25 bar pressure resistant steel braided flex used

FİYAT / PRICE

50386

928.00



LAVABO BATARYASI

- Su tasarrufu özel aeratör (Köpük akış, kireç kırıcı, debi değeri: 8lt/dk)
- İdeal çalışma basıncı 3-4 Bar
- Ürünümsüz ms58/ms63 oranında alçak basınç piriñ külçeden üretiştir.
- Yüzey kaplaması 0.3 mikron krom 7 mikron nikel kaplamadır.
- 25 bar basınca dayanıklı seramik kartuş kullanılmaktadır.
- 3/8 m-10 bar basınca dayanıklı çelik örgülü flex kullanılmıştir.
- 3/8 m-10 bar basınca dayanıklı çelik örgülü flex kullanılmıştir.



WASH BASIN FAUCET

- Water saving special aerator (foam flow, lime breaker, flow rate: 8lt / min)
- Ideal working pressure 3-4 Bar
- Our product is made of MS58/MS63 brass low pressure ingots
- Surface coating is 0.16 mm chrome coating
- 25 bar pressure resistant ceramic cartridge used
- G 3/8 M-10 25 bar pressure resistant steel braided flex used
- G 3/8 M-10 25 bar pressure resistant steel braided flex used

FİYAT / PRICE

50387

1412.00

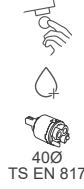

KUĞU EVİYE BATARYASI

- Su tasarrufu özel aeratör (Köpük akış, kireç kırıcı, debi değeri: 8lt/dk)
- İdeal çalışma basıncı 3-4 Bar
- Ürünümüz ms58/ms63 oranında alçak basınç pirinç külçeden üretilmiştir.
- Yüzey kaplaması 0.3 mikron krom 7 mikron nikel kaplamadır.
- 360 derece döner boruludur
- 25 bar basınca dayanıklı seramik kartuş kullanılmaktadır.
- 3/8 m-10 bar basınca dayanıklı çelik örgülü flex kullanılmıştır.

KITCHEN FAUCET

- Water saving special aerator (foam flow, lime breaker, flow rate: 8lt / min)
- Ideal working pressure 3-4 Bar
- Our product is made of MS58/MS63 brass low pressure ingots
- Surface coating is 0.16 mm chrome coating
- 360 degree rotating tube
- 25 bar pressure resistant ceramic cartridge used
- G 3/8 M-10 25 bar pressure resistant steel braided flex used

hareketli perlatör



50383

FİYAT / PRICE

998.00

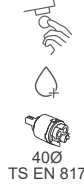

LÜKS KUĞU T BORULU EVİYE BATARYASI

- Su tasarrufu özel aeratör (Köpük akış, kireç kırıcı, debi değeri: 8lt/dk)
- İdeal çalışma basıncı 3-4 Bar
- Ürünümüz ms58/ms63 oranında alçak basınç pirinç külçeden üretilmiştir.
- Yüzey kaplaması 0.3 mikron krom 7 mikron nikel kaplamadır.
- 360 derece döner boruludur
- 25 bar basınca dayanıklı seramik kartuş kullanılmaktadır.
- 3/8 m-10 bar basınca dayanıklı çelik örgülü flex kullanılmıştır.

KITCHEN FAUCET

- Water saving special aerator (foam flow, lime breaker, flow rate: 8lt / min)
- Ideal working pressure 3-4 Bar
- Our product is made of MS58/MS63 brass low pressure ingots
- Surface coating is 0.16 mm chrome coating
- 360 degree rotating tube
- 25 bar pressure resistant ceramic cartridge used
- G 3/8 M-10 25 bar pressure resistant steel braided flex used



50189

FİYAT / PRICE

1005.00

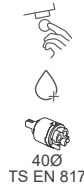

YANDAN APLİK EVİYE BATARYASI

- Su tasarrufu özel aeratör (Köpük akış, kireç kırıcı, debi değeri: 8lt/dk)
- İdeal çalışma basıncı 3-4 Bar
- Ürünümüz ms58/ms63 oranında alçak basınç pirinç külçeden üretilmiştir.
- Yüzey kaplaması 0.3 mikron krom 7 mikron nikel kaplamadır.
- 360 derece döner boruludur
- 25 bar basınca dayanıklı seramik kartuş kullanılmaktadır.
- 3/8 m-10 bar basınca dayanıklı çelik örgülü flex kullanılmıştır.

KITCHEN FAUCET

- Water saving special aerator (foam flow, lime breaker, flow rate: 8lt / min)
- Ideal working pressure 3-4 Bar
- Our product is made of MS58/MS63 brass low pressure ingots
- Surface coating is 0.16 mm chrome coating
- 360 degree rotating tube
- 25 bar pressure resistant ceramic cartridge used
- G 3/8 M-10 25 bar pressure resistant steel braided flex used



50443

FİYAT / PRICE

1528.00



APLİK EVİYE BATARYASI

- Su tasarrufu özel aeratör (Köpük akış, kireç kırıcı, debi değeri: 8lt/dk)
- İdeal çalışma basıncı 3-4 Bar
- Ürünümüz ms58/ms63 oranında alçak basınç pirinç külçeden üretilmiştir.
- Yüzey kaplaması 0.3 mikron krom 7 mikron nikel kaplamadır.
- 360 derece döner boruludur
- 25 bar basınca dayanıklı seramik kartuş kullanılmaktadır.
- 3/8 m-10 bar basınca dayanıklı çelik örgülü flex kullanılmıştır.

KITCHEN FAUCET

- Water saving special aerator (foam flow, lime breaker, flow rate: 8lt / min)
- Ideal working pressure 3-4 Bar
- Our product is made of MS58/MS63 brass low pressure ingots
- Surface coating is 0.16 mm chrome coating
- 360 degree rotating tube
- 25 bar pressure resistant ceramic cartridge used
- G 3/8 M-10 25 bar pressure resistant steel braided flex used



50442

FİYAT / PRICE

1366.00

LARA

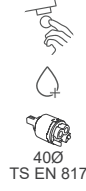

KUŞU EVİYE BATARYASI

- Su tasarrufu özel aeratör (Köpük akış, kireç kırıcı, debi değeri: 8lt/dk)
- İdeal çalışma basıncı 3-4 Bar
- Ürünümsüz ms58/ms63 oranında alçak basınç pirinç külçeden üretilmiştir.
- Yüzey kaplaması 0.3 mikron krom 7 mikron nikel kaplamadır.
- 360 derece döner boruludur
- 25 bar basınca dayanıklı seramik kartuş kullanılmaktadır.
- 3/8 m-10 bar basınca dayanıklı çelik örgülü flex kullanılmıştır.



KITCHEN FAUCET

- Water saving special aerator (foam flow, lime breaker, flow rate: 8lt / min)
- Ideal working pressure 3-4 Bar
- Our product is made of MS58/MS63 brass low pressure ingots
- Surface coating is 0.16 mm chrome coating
- 360 degree rotating tube
- 25 bar pressure resistant ceramic cartridge used
- G 3/8 M-10 25 bar pressure resistant steel braided flex used

FİYAT / PRICE

50384

988.00

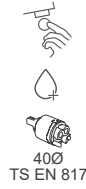

ÇANAK LAVABO BATARYASI

- Su tasarrufu özel aeratör (Köpük akış, kireç kırıcı, debi değeri: 8lt/dk)
- İdeal çalışma basıncı 3-4 Bar
- Ürünümsüz ms58/ms63 oranında alçak basınç pirinç külçeden üretilmiştir.
- Yüzey kaplaması 0.3 mikron krom 7 mikron nikel kaplamadır.
- 360 derece döner boruludur
- 25 bar basınca dayanıklı seramik kartuş kullanılmaktadır.
- 3/8 m-10 bar basınca dayanıklı çelik örgülü flex kullanılmıştır.
- Koli içi 12 adet



WASH BASIN FAUCET

- Water saving special aerator (foam flow, lime breaker, flow rate: 8lt / min)
- Ideal working pressure 3-4 Bar
- Our product is made of MS58/MS63 brass low pressure ingots
- Surface coating is 0.16 mm chrome coating
- 360 degree rotating tube
- 25 bar pressure resistant ceramic cartridge used
- G 3/8 M-10 25 bar pressure resistant steel braided flex used
- Box 12 pieces

KROM

50096

2560.00

SİYAH

50579

2960.00

BEYAZ

50580

2960.00

GOLD

50578

3360.00

FİYAT / PRICE

LARA GOLD



40Ø
TS EN 817

BANYO BATARYASI

- Ürünümsüz MS58/MS63 oranında alçak basınç piriñç külçeden üretiştir.
- Yüzeý kaplaması 0.12 ile 0.16 mikron krom kaplamadır.
- 25 bar basınca dayanıklı seramik kartuş kullanılmaktadır.
- Tesisat baęlantıları G 1/2'dir.
- Koli ii 12 adet



BATHROOM FAUCET

- Our product is made of MS58/MS63 brass low pressure ingots
- Surface coating is 0.16 mm chrome coating
- 25 bar pressure resistant ceramic cartridge used
- Hand shower connections are G 1/2
- Box 12 pieces

FİYAT / PRICE

50427

2230.00



40Ø
TS EN 817

KUĘU EVIYE BATARYASI

- Su tasarrufu özel aeratör (Köpük akış, kireç kırıcı, debi değeri: 8lt/dk)
- İdeal çalışma basıncı 3-4 Bar
- Ürünümsüz ms58/ms63 oranında alçak basınç piriñç külçeden üretiştir.
- Yüzeý kaplaması 0.3 mikron krom 7 mikron nikel kaplamadır.
- 360 derece döner boruludur
- 25 bar basınca dayanıklı seramik kartuş kullanılmaktadır.
- 3/8 m-10 bar basınca dayanıklı çelik örgülü flex kullanılmıřtır.



KITCHEN FAUCET

- Water saving special aerator (foam flow, lime breaker, flow rate: 8lt / min)
- Ideal working pressure 3-4 Bar
- Our product is made of MS58/MS63 brass low pressure ingots
- Surface coating is 0.16 mm chrome coating
- 360 degree rotating tube
- 25 bar pressure resistant ceramic cartridge used
- G 3/8 M-10 25 bar pressure resistant steel braided flex used

FİYAT / PRICE

50409

1728.00



40Ø
TS EN 817

KUĘU LAVABO BATARYASI

- Su tasarrufu özel aeratör (Köpük akış, kireç kırıcı, debi değeri: 8lt/dk)
- İdeal çalışma basıncı 3-4 Bar
- Ürünümsüz ms58/ms63 oranında alçak basınç piriñç külçeden üretiştir.
- Yüzeý kaplaması 0.3 mikron krom 7 mikron nikel kaplamadır.
- 360 derece döner boruludur
- 25 bar basınca dayanıklı seramik kartuş kullanılmaktadır.
- 3/8 m-10 bar basınca dayanıklı çelik örgülü flex kullanılmıřtır.



WASH BASIN FAUCET

- Water saving special aerator (foam flow, lime breaker, flow rate: 8lt / min)
- Ideal working pressure 3-4 Bar
- Our product is made of MS58/MS63 brass low pressure ingots
- Surface coating is 0.16 mm chrome coating
- 360 degree rotating tube
- 25 bar pressure resistant ceramic cartridge used
- G 3/8 M-10 25 bar pressure resistant steel braided flex used

FİYAT / PRICE

50429

1728.00



40Ø
TS EN 817

LAVABO BATARYASI

- Su tasarrufu özel aeratör (Köpük akış, kireç kırıcı, debi değeri: 8lt/dk)
- İdeal çalışma basıncı 3-4 Bar
- Ürünümsüz ms58/ms63 oranında alçak basınç piriñç külçeden üretiştir.
- Yüzeý kaplaması 0.3 mikron krom 7 mikron nikel kaplamadır.
- 25 bar basınca dayanıklı seramik kartuş kullanılmaktadır.
- 3/8 m-10 bar basınca dayanıklı çelik örgülü flex kullanılmıřtır.
- 3/8 m-10 bar basınca dayanıklı çelik örgülü flex kullanılmıřtır.



WASH BASIN FAUCET

- Water saving special aerator (foam flow, lime breaker, flow rate: 8lt / min)
- Ideal working pressure 3-4 Bar
- Our product is made of MS58/MS63 brass low pressure ingots
- Surface coating is 0.16 mm chrome coating
- 25 bar pressure resistant ceramic cartridge used
- G 3/8 M-10 25 bar pressure resistant steel braided flex used
- G 3/8 M-10 25 bar pressure resistant steel braided flex used

FİYAT / PRICE

50430

2212.00

LARA WHITE



BANYO BATARYASI

- Ürünümsüz MS58/MS63 oranında alçak basınç pirinç külçeden üretilmiştir.
- Yüzey kaplaması 0.12 ile 0.16 mikron krom kaplamadır.
- 25 bar basınca dayanıklı seramik kartuş kullanılmaktadır.
- Tesisat bağlantıları G 1/2'dir.
- Koli içi 12 adet



BATHROOM FAUCET

- Our product is made of MS58/MS63 brass low pressure ingots
- Surface coating is 0.16 mm chrome coating
- 25 bar pressure resistant ceramic cartridge used
- Hand shower connections are G 1/2
- Box 12 pieces

FİYAT / PRICE

50435

1830.00

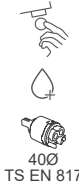

KUĞU EVİYE BATARYASI

- Su tasarrufu özel aeratör (Köpük akış, kireç kırıcı, debi değeri: 8lt/dk)
- İdeal çalışma basıncı 3-4 Bar
- Ürünümsüz ms58/ms63 oranında alçak basınç pirinç külçeden üretilmiştir.
- Yüzey kaplaması 0.3 mikron krom 7 mikron nikel kaplamadır.
- 360 derece döner boruludur
- 25 bar basınca dayanıklı seramik kartuş kullanılmaktadır.
- 3/8 m-10 bar basınca dayanıklı çelik örgülü flex kullanılmıştır.



KITCHEN FAUCET

- Water saving special aerator (foam flow, lime breaker, flow rate: 8lt / min)
- Ideal working pressure 3-4 Bar
- Our product is made of MS58/MS63 brass low pressure ingots
- Surface coating is 0.16 mm chrome coating
- 360 degree rotating tube
- 25 bar pressure resistant ceramic cartridge used
- G 3/8 M-10 25 bar pressure resistant steel braided flex used

FİYAT / PRICE

50410

1328.00



KUĞU LAVABO BATARYASI

- Su tasarrufu özel aeratör (Köpük akış, kireç kırıcı, debi değeri: 8lt/dk)
- İdeal çalışma basıncı 3-4 Bar
- Ürünümsüz ms58/ms63 oranında alçak basınç pirinç külçeden üretilmiştir.
- Yüzey kaplaması 0.3 mikron krom 7 mikron nikel kaplamadır.
- 360 derece döner boruludur
- 25 bar basınca dayanıklı seramik kartuş kullanılmaktadır.
- 3/8 m-10 bar basınca dayanıklı çelik örgülü flex kullanılmıştır.



WASH BASIN FAUCET

- Water saving special aerator (foam flow, lime breaker, flow rate: 8lt / min)
- Ideal working pressure 3-4 Bar
- Our product is made of MS58/MS63 brass low pressure ingots
- Surface coating is 0.16 mm chrome coating
- 360 degree rotating tube
- 25 bar pressure resistant ceramic cartridge used
- G 3/8 M-10 25 bar pressure resistant steel braided flex used

FİYAT / PRICE

50437

1328.00



LAVABO BATARYASI

- Su tasarrufu özel aeratör (Köpük akış, kireç kırıcı, debi değeri: 8lt/dk)
- İdeal çalışma basıncı 3-4 Bar
- Ürünümsüz ms58/ms63 oranında alçak basınç pirinç külçeden üretilmiştir.
- Yüzey kaplaması 0.3 mikron krom 7 mikron nikel kaplamadır.
- 25 bar basınca dayanıklı seramik kartuş kullanılmaktadır.
- 3/8 m-10 bar basınca dayanıklı çelik örgülü flex kullanılmıştır.
- 3/8 m-10 bar basınca dayanıklı çelik örgülü flex kullanılmıştır.



WASH BASIN FAUCET

- Water saving special aerator (foam flow, lime breaker, flow rate: 8lt / min)
- Ideal working pressure 3-4 Bar
- Our product is made of MS58/MS63 brass low pressure ingots
- Surface coating is 0.16 mm chrome coating
- 25 bar pressure resistant ceramic cartridge used
- G 3/8 M-10 25 bar pressure resistant steel braided flex used
- G 3/8 M-10 25 bar pressure resistant steel braided flex used

FİYAT / PRICE

50438

1812.00

LARA BLACK

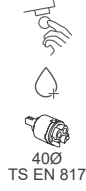

BANYO BATARYASI

- Ürünümüz MS58/MS63 oranında alçak basınç pirinç külçeden üretilmiştir.
- Yüze kaplaması 0.12 ile 0.16 mikron krom kaplamadır.
- 25 bar basınca dayanıklı seramik kartuş kullanılmaktadır.
- Tesisat bağlantıları G 1/2'dir.
- Koli içi 12 adet



BATHROOM FAUCET

- Our product is made of MS58/MS63 brass low pressure ingots
- Surface coating is 0.16 mm chrome coating
- 25 bar pressure resistant ceramic cartridge used
- Hand shower connections are G 1/2
- Box 12 pieces

FİYAT / PRICE

50431

1830.00



KUĞU EVİYE BATARYASI

- Su tasarrufu özel aeratör (Köpük akış, kireç kırıcı, debi değeri: 8lt/dk)
- İdeal çalışma basıncı 3-4 Bar
- Ürünümüz ms58/ms63 oranında alçak basınç pirinç külçeden üretilmiştir.
- Yüze kaplaması 0.3 mikron krom 7 mikron nikel kaplamadır.
- 360 derece döner boruludur
- 25 bar basınca dayanıklı seramik kartuş kullanılmaktadır.
- 3/8 m-10 bar basınca dayanıklı çelik örgülü flex kullanılmıştır.



KITCHEN FAUCET

- Water saving special aerator (foam flow, lime breaker, flow rate: 8lt / min)
- Ideal working pressure 3-4 Bar
- Our product is made of MS58/MS63 brass low pressure ingots
- Surface coating is 0.16 mm chrome coating
- 360 degree rotating tube
- 25 bar pressure resistant ceramic cartridge used
- G 3/8 M-10 25 bar pressure resistant steel braided flex used

FİYAT / PRICE

50411

1328.00



KUĞU LAVABO BATARYASI

- Su tasarrufu özel aeratör (Köpük akış, kireç kırıcı, debi değeri: 8lt/dk)
- İdeal çalışma basıncı 3-4 Bar
- Ürünümüz ms58/ms63 oranında alçak basınç pirinç külçeden üretilmiştir.
- Yüze kaplaması 0.3 mikron krom 7 mikron nikel kaplamadır.
- 360 derece döner boruludur
- 25 bar basınca dayanıklı seramik kartuş kullanılmaktadır.
- 3/8 m-10 bar basınca dayanıklı çelik örgülü flex kullanılmıştır.



WASH BASIN FAUCET

- Water saving special aerator (foam flow, lime breaker, flow rate: 8lt / min)
- Ideal working pressure 3-4 Bar
- Our product is made of MS58/MS63 brass low pressure ingots
- Surface coating is 0.16 mm chrome coating
- 360 degree rotating tube
- 25 bar pressure resistant ceramic cartridge used
- G 3/8 M-10 25 bar pressure resistant steel braided flex used

FİYAT / PRICE

50433

1328.00

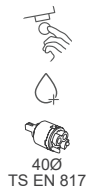

LAVABO BATARYASI

- Su tasarrufu özel aeratör (Köpük akış, kireç kırıcı, debi değeri: 8lt/dk)
- İdeal çalışma basıncı 3-4 Bar
- Ürünümüz ms58/ms63 oranında alçak basınç pirinç külçeden üretilmiştir.
- Yüze kaplaması 0.3 mikron krom 7 mikron nikel kaplamadır.
- 25 bar basınca dayanıklı seramik kartuş kullanılmaktadır.
- 3/8 m-10 bar basınca dayanıklı çelik örgülü flex kullanılmıştır.
- 3/8 m-10 bar basınca dayanıklı çelik örgülü flex kullanılmıştır.



WASH BASIN FAUCET

- Water saving special aerator (foam flow, lime breaker, flow rate: 8lt / min)
- Ideal working pressure 3-4 Bar
- Our product is made of MS58/MS63 brass low pressure ingots
- Surface coating is 0.16 mm chrome coating
- 25 bar pressure resistant ceramic cartridge used
- G 3/8 M-10 25 bar pressure resistant steel braided flex used
- G 3/8 M-10 25 bar pressure resistant steel braided flex used

FİYAT / PRICE

50434

1812.00



BANYO BATARYASI

- Ürünümsüz MS58/MS63 oranında alçak basınç pirinç külçeden üretilmiştir.
- Yüze kaplaması 0.12 ile 0.16 mikron krom kaplamadır.
- 25 bar basınca dayanıklı seramik kartuş kullanılmaktadır.
- Tesisat bağlantıları G 1/2'dir.
- Koli içi 12 adet



BATHROOM FAUCET

- Our product is made of MS58/MS63 brass low pressure ingots
- Surface coating is 0.16 mm chrome coating
- 25 bar pressure resistant ceramic cartridge used
- Hand shower connections are G ½
- Box 12 pieces

FIYAT / PRICE

50087

1150.00



KUĞU EVİYE BATARYASI

- Su tasarrufu özel aeratör (Köpük akış. kireç kırıcı. debi değeri: 8lt/dk)
- İdeal çalışma basıncı 3-4 Bar
- Ürünümsüz ms58/ms63 oranında alçak basınç pirinç külçeden üretilmiştir.
- Yüze kaplaması 0.3 mikron krom 7 mikron nikel kaplamadır.
- 360 derece döner boruludur
- 25 bar basınca dayanıklı seramik kartuş kullanılmaktadır.
- 3/8 m-10 bar basınca dayanıklı çelik örgülü flex kullanılmıştır.



KITCHEN FAUCET

- Water saving special aerator (foam flow. lime breaker. flow rate: 8lt / min)
- Ideal working pressure 3-4 Bar
- Our product is made of MS58/MS63 brass low pressure ingots
- Surface coating is 0.16 mm chrome coating
- 360 degree rotating tube
- 25 bar pressure resistant ceramic cartridge used
- G 3/8 M-10 25 bar pressure resistant steel braided flex used

FIYAT / PRICE

50089

680.00



KUĞU LAVABO BATARYASI

- Su tasarrufu özel aeratör (Köpük akış. kireç kırıcı. debi değeri: 8lt/dk)
- İdeal çalışma basıncı 3-4 Bar
- Ürünümsüz ms58/ms63 oranında alçak basınç pirinç külçeden üretilmiştir.
- Yüze kaplaması 0.3 mikron krom 7 mikron nikel kaplamadır.
- 360 derece döner boruludur
- 25 bar basınca dayanıklı seramik kartuş kullanılmaktadır.
- 3/8 m-10 bar basınca dayanıklı çelik örgülü flex kullanılmıştır.



WASH BASIN FAUCET

- Water saving special aerator (foam flow. lime breaker. flow rate: 8lt / min)
- Ideal working pressure 3-4 Bar
- Our product is made of MS58/MS63 brass low pressure ingots
- Surface coating is 0.16 mm chrome coating
- 360 degree rotating tube
- 25 bar pressure resistant ceramic cartridge used
- G 3/8 M-10 25 bar pressure resistant steel braided flex used

FIYAT / PRICE

50088

680.00



LAVABO BATARYASI

- Su tasarrufu özel aeratör (Köpük akış. kireç kırıcı. debi değeri: 8lt/dk)
- İdeal çalışma basıncı 3-4 Bar
- Ürünümsüz ms58/ms63 oranında alçak basınç pirinç külçeden üretilmiştir.
- Yüze kaplaması 0.3 mikron krom 7 mikron nikel kaplamadır.
- 25 bar basınca dayanıklı seramik kartuş kullanılmaktadır.
- 3/8 m-10 bar basınca dayanıklı çelik örgülü flex kullanılmıştır.
- 3/8 m-10 bar basınca dayanıklı çelik örgülü flex kullanılmıştır.



WASH BASIN FAUCET

- Water saving special aerator (foam flow. lime breaker. flow rate:8lt / min)
- Ideal working pressure 3-4 Bar
- Our product is made of MS58/MS63 brass low pressure ingots
- Surface coating is 0.16 mm chrome coating
- 25 bar pressure resistant ceramic cartridge used
- G 3/8 M-10 25 bar pressure resistant steel braided flex used
- G 3/8 M-10 25 bar pressure resistant steel braided flex used

FIYAT / PRICE

50090

1065.00



40Ø
TS EN 817

KARTAL LAVABO BATARYASI

- Su tasarrufu özel aeratör (Köpük akış, kireç kırıcı, debi değeri: 8lt/dk)
- İdeal çalışma basıncı 3-4 Bar
- Ürünümüz ms58/ms63 oranında alçak basınç pirinç külçeden üretilmiştir.
- Yüzey kaplaması 0.3 mikron krom 7 mikron nikel kaplamadır.
- 25 bar basınca dayanıklı seramik kartuş kullanılmaktadır.
- 3/8 m-10 bar basınca dayanıklı çelik örgülü flex kullanılmıştır.
- 3/8 m-10 bar basınca dayanıklı çelik örgülü flex kullanılmıştır.



WASH BASIN FAUCET

- Water saving special aerator (foam flow, lime breaker, flow rate:8lt / min)
- Ideal working pressure 3-4 Bar
- Our product is made of MS58/MS63 brass low pressure ingots
- Surface coating is 0.16 mm chrome coating
- 25 bar pressure resistant ceramic cartridge used
- G 3/8 M-10 25 bar pressure resistant steel braided flex used
- G 3/8 M-10 25 bar pressure resistant steel braided flex used

FİYAT / PRICE

50575

1298.00



40Ø
TS EN 817

YÜKSEK LAVABO BATARYASI

- Su tasarrufu özel aeratör (Köpük akış, kireç kırıcı, debi değeri: 8lt/dk)
- İdeal çalışma basıncı 3-4 Bar
- Ürünümüz ms58/ms63 oranında alçak basınç pirinç külçeden üretilmiştir.
- Yüzey kaplaması 0.3 mikron krom 7 mikron nikel kaplamadır.
- 25 bar basınca dayanıklı seramik kartuş kullanılmaktadır.
- 3/8 m-10 bar basınca dayanıklı çelik örgülü flex kullanılmıştır.
- 3/8 m-10 bar basınca dayanıklı çelik örgülü flex kullanılmıştır.



WASH BASIN FAUCET

- Water saving special aerator (foam flow, lime breaker, flow rate:8lt / min)
- Ideal working pressure 3-4 Bar
- Our product is made of MS58/MS63 brass low pressure ingots
- Surface coating is 0.16 mm chrome coating
- 25 bar pressure resistant ceramic cartridge used
- G 3/8 M-10 25 bar pressure resistant steel braided flex used
- G 3/8 M-10 25 bar pressure resistant steel braided flex used

FİYAT / PRICE

50197

1282.00



40Ø
TS EN 817

KUĞU EVİYE BATARYASI BASTON BORULU

- Ürünümüz MS58/MS63 oranında alçak basınç pirinç külçeden üretilmiştir.
- Yüzey kaplaması 0.12 ile 0.16 mikron krom kaplamadır.
- 25 bar basınca dayanıklı seramik kartuş kullanılmaktadır.
- Tesisat bağlantıları G 1/2 dir.
- Koli içi 12 adet

KITCHEN FAUCET

- Our product is made of MS58/MS63 brass low pressure ingots
- Surface coating is 0.16 mm chrome coating
- 25 bar pressure resistant ceramic cartridge used
- Hand shower connections are G 1/2
- Box 12 pieces

FİYAT / PRICE

50573

720.00



40Ø
TS EN 817

KUĞU LAVABO BATARYASI BASTON BORULU

- Su tasarrufu özel aeratör (Köpük akış, kireç kırıcı, debi değeri: 8lt/dk)
- İdeal çalışma basıncı 3-4 Bar
- Ürünümüz ms58/ms63 oranında alçak basınç pirinç külçeden üretilmiştir.
- Yüzey kaplaması 0.3 mikron krom 7 mikron nikel kaplamadır.
- 25 bar basınca dayanıklı seramik kartuş kullanılmaktadır.
- 3/8 m-10 bar basınca dayanıklı çelik örgülü flex kullanılmıştır.
- 3/8 m-10 bar basınca dayanıklı çelik örgülü flex kullanılmıştır.

WASH BASIN FAUCET

- Water saving special aerator (foam flow, lime breaker, flow rate:8lt / min)
- Ideal working pressure 3-4 Bar
- Our product is made of MS58/MS63 brass low pressure ingots
- Surface coating is 0.16 mm chrome coating
- 25 bar pressure resistant ceramic cartridge used
- G 3/8 M-10 25 bar pressure resistant steel braided flex used
- G 3/8 M-10 25 bar pressure resistant steel braided flex used

FİYAT / PRICE

50574

720.00



DÖNER EVİYE BATARYASI

- Su tasarrufu özel aeratör (Köpük akış, kireç kırıcı, debi değeri: 8lt/dk)
- İdeal çalışma basıncı 3-4 Bar
- Ürünümüz ms58/ms63 oranında alçak basınç pirinç külçeden üretilmiştir.
- Yüzey kaplaması 0.3 mikron krom 7 mikron nikel kaplamadır.
- 360 derece döner boruludur
- 25 bar basınca dayanıklı seramik kartuş kullanılmaktadır.
- 3/8 m-10 bar basınca dayanıklı çelik örgülü flex kullanılmıştır.

KITCHEN FAUCET

- Water saving special aerator (foam flow, lime breaker, flow rate: 8lt / min)
- Ideal working pressure 3-4 Bar
- Our product is made of MS58/MS63 brass low pressure ingots
- Surface coating is 0.16 mm chrome coating
- 360 degree rotating tube
- 25 bar pressure resistant ceramic cartridge used
- G 3/8 M-10 25 bar pressure resistant steel braided flex used



FİYAT / PRICE

50034

1034.00



DÖNER LAVABO BATARYASI

- Su tasarrufu özel aeratör (Köpük akış, kireç kırıcı, debi değeri: 8lt/dk)
- İdeal çalışma basıncı 3-4 Bar
- Ürünümüz ms58/ms63 oranında alçak basınç pirinç külçeden üretilmiştir.
- Yüzey kaplaması 0.3 mikron krom 7 mikron nikel kaplamadır.
- 25 bar basınca dayanıklı seramik kartuş kullanılmaktadır.
- 3/8 m-10 bar basınca dayanıklı çelik örgülü flex kullanılmıştır.
- 3/8 m-10 bar basınca dayanıklı çelik örgülü flex kullanılmıştır.

WASH BASIN FAUCET

- Water saving special aerator (foam flow, lime breaker, flow rate: 8lt / min)
- Ideal working pressure 3-4 Bar
- Our product is made of MS58/MS63 brass low pressure ingots
- Surface coating is 0.16 mm chrome coating
- 25 bar pressure resistant ceramic cartridge used
- G 3/8 M-10 25 bar pressure resistant steel braided flex used
- G 3/8 M-10 25 bar pressure resistant steel braided flex used



FİYAT / PRICE

50037

1034.00



APLIK ŞATTAFLI BATARYASI

- Su tasarrufu özel aeratör (Köpük akış, kireç kırıcı, debi değeri: 8lt/dk)
- İdeal çalışma basıncı 3-4 Bar
- Ürünümüz ms58/ms63 oranında alçak basınç pirinç külçeden üretilmiştir.
- Yüzey kaplaması 0.3 mikron krom 7 mikron nikel kaplamadır.
- 25 bar basınca dayanıklı seramik kartuş kullanılmaktadır.
- 3/8 m-10 bar basınca dayanıklı çelik örgülü flex kullanılmıştır.
- Koli içi 12 adet

SHUT-OFF FAUCET

- Water saving special aerator (foam flow, lime breaker, flow rate: 8lt / min)
- Ideal working pressure 3-4 Bar
- Our product is made of MS58/MS63 brass low pressure ingots
- Surface coating is 0.16 mm chrome coating
- 25 bar pressure resistant ceramic cartridge used
- G 3/8 M-10 25 bar pressure resistant steel braided flex used
- Box 12 pieces



ŞATTAFLISIZ

50318

982.00

ŞATTAFLI

50162

FİYAT / PRICE

1132.00



APLİK EVİYE BATARYASI

- Su tasarrufu özel aeratör (Köpük akış, kireç kırıcı, debi değeri: 8lt/dk)
- İdeal çalışma basıncı 3-4 Bar
- Ürünümsüz ms58/ms63 oranında alçak basınç pirinç külçeden üretilmiştir.
- Yüzey kaplaması 0.3 mikron krom 7 mikron nikel kaplamadır.
- 360 derece döner boruludur
- 25 bar basınca dayanıklı seramik kartuş kullanılmaktadır.
- 3/8 m-10 bar basınca dayanıklı çelik örgülü flex kullanılmıştır.

KITCHEN FAUCET

- Water saving special aerator (foam flow, lime breaker, flow rate: 8lt / min)
- Ideal working pressure 3-4 Bar
- Our product is made of MS58/MS63 brass low pressure ingots
- Surface coating is 0.16 mm chrome coating
- 360 degree rotating tube
- 25 bar pressure resistant ceramic cartridge used
- G 3/8 M-10 25 bar pressure resistant steel braided flex used



FİYAT / PRICE

50266

1170.00

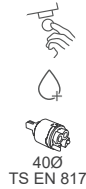

TERS APLİK EVİYE BATARYASI

- Su tasarrufu özel aeratör (Köpük akış, kireç kırıcı, debi değeri: 8lt/dk)
- İdeal çalışma basıncı 3-4 Bar
- Ürünümsüz ms58/ms63 oranında alçak basınç pirinç külçeden üretilmiştir.
- Yüzey kaplaması 0.3 mikron krom 7 mikron nikel kaplamadır.
- 360 derece döner boruludur
- 25 bar basınca dayanıklı seramik kartuş kullanılmaktadır.
- 3/8 m-10 bar basınca dayanıklı çelik örgülü flex kullanılmıştır.

KITCHEN FAUCET

- Water saving special aerator (foam flow, lime breaker, flow rate: 8lt / min)
- Ideal working pressure 3-4 Bar
- Our product is made of MS58/MS63 brass low pressure ingots
- Surface coating is 0.16 mm chrome coating
- 360 degree rotating tube
- 25 bar pressure resistant ceramic cartridge used
- G 3/8 M-10 25 bar pressure resistant steel braided flex used



FİYAT / PRICE

50265

1280.00



BİDE BATARYASI

- Su tasarrufu özel aeratör (Köpük akış, kireç kırıcı, debi değeri: 8lt/dk)
- İdeal çalışma basıncı 3-4 Bar
- Ürünümsüz ms58/ms63 oranında alçak basınç pirinç külçeden üretilmiştir.
- Yüzey kaplaması 0.3 mikron krom 7 mikron nikel kaplamadır.
- 25 bar basınca dayanıklı seramik kartuş kullanılmaktadır.
- 3/8 m-10 bar basınca dayanıklı çelik örgülü flex kullanılmıştır.
- 3/8 m-10 bar basınca dayanıklı çelik örgülü flex kullanılmıştır.

BİDE FAUCET

- Water saving special aerator (foam flow, lime breaker, flow rate: 8lt / min)
- Ideal working pressure 3-4 Bar
- Our product is made of MS58/MS63 brass low pressure ingots
- Surface coating is 0.16 mm chrome coating
- 25 bar pressure resistant ceramic cartridge used
- G 3/8 M-10 25 bar pressure resistant steel braided flex used
- G 3/8 M-10 25 bar pressure resistant steel braided flex used



FİYAT / PRICE

50322

1104.00



BANYO BATARYASI
KOLİ 12

BATHROOM FAUCET
KOLİ 12



FIYAT / PRICE

50001

1412.00



DÖNER EVİYE BATARYASI
KOLİ 12

KITCHEN FAUCET
KOLİ 12



FIYAT / PRICE

50002

894.00



KARTAL LAVABO BATARYASI **EAGLE WASH BASIN FAUCET**
KOLİ 12



FIYAT / PRICE

50004

1666.00



KISA KUĞU LAVABO BATARYASI
KOLİ 12

SWAN FAUCET
KOLİ 12



FIYAT / PRICE

50217

890.00



KÜRESEL BANYO BATARYASI
KOLİ 12

BATHROOM FAUCET
KOLİ 12



50262

FİYAT / PRICE

1556.00



KUĞU LAVABO BATARYASI
KOLİ 12

SWAN FAUCET
KOLİ 12



50005

FİYAT / PRICE

890.00



DÖNER LAVABO BATARYASI
KOLİ 12

WASH BASIN FAUCET



50101

FİYAT / PRICE

894.00



SABİT LAVABO BATARYASI
KOLİ 12

WASH BASIN FAUCET



50003

FİYAT / PRICE

1026.00



KÖPRÜ BATARYASI
KOLİ 12

BRIDGE FAUCET
KOLİ 12



50169

FİYAT / PRICE

1230.00

TEK GİRİŞLİ



MİX LAVABO BATARYASI
KOLİ 12

WASH BASIN FAUCET



50074

FİYAT / PRICE

952.00



DUVARDAN LAVABO BATARYASI
KOLİ 12

WASH BASIN FAUCET



50215

FİYAT / PRICE

528.00



TEKLİ EVİYE BATARYASI
KOLİ 12

KITCHEN FAUCET
KOLİ 12



50007

FİYAT / PRICE

400.00



TEKLİ MERMERÜSTÜ EVİYE BATARYASI
KOLİ 12

KITCHEN FAUCET
KOLİ 12



50006

FİYAT / PRICE

516.00

TEK GİRİŞLİ



MİX LAVABO BATARYASI
KOLİ 12

WASH BASIN FAUCET



50038

FİYAT / PRICE

550.00



MİX YANDANLAVABO BATARYASI
KOLİ 12

WASH BASIN FAUCET



50039

FİYAT / PRICE

492.00



MİX LAVABO BATARYASI
KOLİ 12

WASH BASIN FAUCET



50214

FİYAT / PRICE

586.00



MIX UZUN MUSLUK



50015

FİYAT / PRICE

454.00

TEKLİ MUSLUKLAR



50012 Kısa Musluk Poşetli (Aynasız)

FİYAT / PRICE
250.00

50009 Lüks Kısa Musluk Kutulu TS EN 200



326.00



50011 Uzun Musluk Poşetli (Aynasız)

FİYAT / PRICE
250.00

50008 Lüks Uzun Musluk Kutulu TS EN 200



326.00



50013 Çamaşır Musluğu Poşetli (Aynasız)

FİYAT / PRICE
250.00

50010 Lüks Çamaşır Musluğu Kutulu TS EN 200



326.00



51730 Küresel Bahçe Musluğu 1/2"

FİYAT / PRICE
155.00

51731 Küresel Bahçe Musluğu 3/4"



178.00



DELTA



ALFA



FİYAT / PRICE

50456 Delta Lüks Kısa Musluk Kutulu TS EN 200

352.00

50165 Alfa Kısa Musluk Poşetli Aynasız

276.00

50173 Alfa Lüks Kısa Musluk Kutulu TS EN 200

352.00



DELTA



ALFA



FİYAT / PRICE

50223 Delta Lüks Uzun Musluk Kutulu TS EN 200

352.00

50166 Alfa Uzun Musluk Poşetli Aynasız

276.00

50182 Alfa Lüks Uzun Musluk Kutulu TS EN 200

352.00



DELTA



ALFA



FİYAT / PRICE

50455 Delta Lüks Çamaşır Musluğu Kutulu TS EN 200

352.00

50459 Alfa Çamaşır Musluk Poşetli Aynasız

276.00

50183 Alfa Lüks Çamaşır Musluğu Kutulu TS EN 200

352.00



ARA MUSLUKLAR



50404 Alfa Ara Musluk 1/2 x 3/8

FİYAT / PRICE

240.00

50576 Alfa Ara Musluk Aç-Kapa

250.00



50258 Kibris Taharet Musluğu 3/8-3/8

FİYAT / PRICE

226.00



50016 Filtreli Taharet Musluğu Kumlu



FİYAT / PRICE

94.00



FİYAT / PRICE

50023 Acem Kapak Takımı 1. Kalite

102.00

50231 Acem Kapak Takımı (Blister)

112.00

50024 Acem Kapak Takımı Aç Kapa

122.00

50232 Acem Kapak Takımı Aç Kapa (Blister)

132.00



50451 Kumlu Küresel Çamaşır Musluğu 3/4x1/2



116.00
FİYAT / PRICE



50025 Acem Volan

FİYAT / PRICE

56.00

50599 Alfa Volan

82.00



FİYAT / PRICE

50027 Salmastra 17 lik

64.00

50028 Salmastra 15 lik

56.00

50029 Salmastra Aç Kapa

74.00

ARA MUSLUKLAR



50079 Çubuk Taharet Musluğu Aç-Kapa



FİYAT / PRICE

210.00



50235 Artı Taharet Musluğu Aç-Kapa



FİYAT / PRICE

232.00

50577 Güney Koç Taharet Musluğu

180.00



50021 Acem Taharet Musluğu 1/2 x 3/8



FİYAT / PRICE

214.00



50259 Ultra Taharet Musluğu 1/2 x 3/8 İri Gövdeli



FİYAT / PRICE

238.00

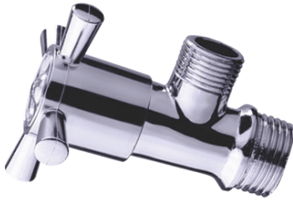

50020 Koç Taharet Musluğu



FİYAT / PRICE

116.00



50396 Delta Ara Musluk



FİYAT / PRICE

238.00



50019 Gonca Taharet Musluğu



FİYAT / PRICE

116.00



50017 Taharet Musluğu Kumlu



FİYAT / PRICE

84.00

UZATMALAR



KROM UZATMALAR

FİYAT / PRICE

51168	3/4"	Bas Uzatma	32.00
51169	3/4"	Delikli Batarya Uzatma	90.00
51170	3/4"	Deliksiz Batarya Uzatma	84.00
51171	1/2"	Delikli Uzatma	68.00
51172	3/4"	Çamaşır Musluğu Çatal	80.00



UZATMALAR

FİYAT / PRICE

51161	1/2"	Krom Uzatma	1 cm	22.00
51162	1/2"	Krom Uzatma	1.5 cm	26.00
51163	1/2"	Krom Uzatma	2 cm	32.00
51164	1/2"	Krom Uzatma	2.5 cm	36.00
51165	1/2"	Krom Uzatma	3 cm	42.00
51166	1/2"	Krom Uzatma	4 cm	52.00
51167	1/2"	Krom Uzatma	5 cm	60.00



TSE UZATMALAR

FİYAT / PRICE

51688	1/2"	Krom Uzatma	1 cm	38.00
51689	1/2"	Krom Uzatma	1.5 cm	44.00
51690	1/2"	Krom Uzatma	2 cm	54.00
51691	1/2"	Krom Uzatma	2.5 cm	60.00
51692	1/2"	Krom Uzatma	3 cm	66.00
51693	1/2"	Krom Uzatma	4 cm	86.00
51694	1/2"	Krom Uzatma	5 cm	108.00

3/4 UZATMALAR

FİYAT / PRICE

51173	3/4"	Krom Uzatma	1 cm	36.00
51174	3/4"	Krom Uzatma	1.5 cm	42.00
51175	3/4"	Krom Uzatma	2 cm	48.00
51176	3/4"	Krom Uzatma	2.5 cm	54.00
51177	3/4"	Krom Uzatma	3 cm	60.00



FLEKSLER

FİYAT / PRICE

3/8x3/8

51632	Çelik Örgülü Hortum Bağlantısı	3/8x3/8	30 cm	25 Ad.	44.00
51637	Çelik Örgülü Hortum Bağlantısı	3/8x3/8	40 cm	25 Ad.	51.00
51642	Çelik Örgülü Hortum Bağlantısı	3/8x3/8	50 cm	25 Ad.	52.00
51647	Çelik Örgülü Hortum Bağlantısı	3/8x3/8	60 cm	25 Ad.	60.00
51652	Çelik Örgülü Hortum Bağlantısı	3/8x3/8	70 cm	25 Ad.	61.00
51657	Çelik Örgülü Hortum Bağlantısı	3/8x3/8	80 cm	25 Ad.	74.00
51667	Çelik Örgülü Hortum Bağlantısı	3/8x3/8	100 cm	25 Ad.	75.00

FİYAT / PRICE

3/8x1/2

51633	Çelik Örgülü Hortum Bağlantısı	3/8x1/2	30 cm	25 Ad.	53.00
51638	Çelik Örgülü Hortum Bağlantısı	3/8x1/2	40 cm	25 Ad.	63.00
51643	Çelik Örgülü Hortum Bağlantısı	3/8x1/2	50 cm	25 Ad.	64.00
51648	Çelik Örgülü Hortum Bağlantısı	3/8x1/2	60 cm	25 Ad.	72.00
51653	Çelik Örgülü Hortum Bağlantısı	3/8x1/2	70 cm	25 Ad.	73.00
51658	Çelik Örgülü Hortum Bağlantısı	3/8x1/2	80 cm	25 Ad.	90.00
51668	Çelik Örgülü Hortum Bağlantısı	3/8x1/2	100 cm	25 Ad.	91.00

FİYAT / PRICE

1/2x1/2

51634	Çelik Örgülü Hortum Bağlantısı	1/2x1/2	30 cm	25 Ad.	61.00
51639	Çelik Örgülü Hortum Bağlantısı	1/2x1/2	40 cm	25 Ad.	69.00
51644	Çelik Örgülü Hortum Bağlantısı	1/2x1/2	50 cm	25 Ad.	70.00
51649	Çelik Örgülü Hortum Bağlantısı	1/2x1/2	60 cm	25 Ad.	79.00
51654	Çelik Örgülü Hortum Bağlantısı	1/2x1/2	70 cm	25 Ad.	80.00
51659	Çelik Örgülü Hortum Bağlantısı	1/2x1/2	80 cm	25 Ad.	92.00
51669	Çelik Örgülü Hortum Bağlantısı	1/2x1/2	100 cm	25 Ad.	93.00

FİYAT / PRICE

51673	Batarya Altı Bağlantısı Çelik		40 cm	25 Ad.	50.00
51674	Batarya Altı Bağlantısı Çelik		50 cm	25 Ad.	54.00
51675	Batarya Altı Bağlantısı Çelik		60 cm	25 Ad.	58.00
51676	Batarya Altı Bağlantısı Çelik		70 cm	25 Ad.	62.00
51679	Batarya Altı Bağlantısı Çelik		100 cm	25 Ad.	75.00

FİYAT / PRICE

51537	Nipelli Flex Bağlantısı Çelik Örgülü	3/8 D x 3/8 E	30 cm	25 Ad.	57.00
51538	Nipelli Flex Bağlantısı Çelik Örgülü	3/8 D x 3/8 E	50 cm	25 Ad.	65.00
51539	Nipelli Flex Bağlantısı Çelik Örgülü	3/8 D x 3/8 E	70 cm	25 Ad.	74.00
51540	Nipelli Flex Bağlantısı Çelik Örgülü	3/8 D x 3/8 E	100 cm	25 Ad.	90.00

51541	Nipelli Flex Bağlantısı Çelik Örgülü	1/2 D x 1/2 E	30 cm	25 Ad.	71.00
51542	Nipelli Flex Bağlantısı Çelik Örgülü	1/2 D x 1/2 E	50 cm	25 Ad.	80.00
51543	Nipelli Flex Bağlantısı Çelik Örgülü	1/2 D x 1/2 E	70 cm	25 Ad.	88.00
51544	Nipelli Flex Bağlantısı Çelik Örgülü	1/2 D x 1/2 E	100 cm	25 Ad.	100.00



BATARYA YEDEK PARÇALARI

FİYAT / PRICE



50132	Mix Kartuş 35	64.00
50251	Mix Kartuş 40	64.00
50133	Mix Kolu 35	50.00
50252	Mix Kolu 40	58.00
50134	Perlatör	16.00
50135	Batarya Dirseği	40.00
50136	Batarya Nipeli	26.00
50137	Batarya Rozeti (Batarya Aynası)	10.00
50138	Mix Kuğu Eviye Borusu	92.00
50253	Mix Kuğu Lavabo Borusu	90.00
50466	Mix Aplik Borusu	92.00
50139	Klasik Eviye Borusu Paslanmaz	56.00
50140	Klasik Kuğu Borusu	56.00
50141	Saplama Takımı	18.00
50142	Batarya Rozet Takımı	50.00
51518	Musluk Aynası	12.00
B1266	Mix Delta Eviye Borusu	110.00
50104	Oynar Perlatör Joystick	78.00
B1279	Mix Delta Lavabo Borusu	106.00
B0572	Batarya Arkası Somunu	46.00

FOTOSELLİ ÜRÜNLER

NEW



Tek Su Girişli



FİYAT / PRICE
3100.00

50401
URANÜS FOTOSELLİ LAVABO BATARYASI

NEW



Tek Su Girişli



50402
VENÜS FOTOSELLİ ÇANAK LAVABO BATARYASI 4890.00

FİYAT / PRICE

NEW



Tek Su Girişli



FİYAT / PRICE
2850.00

50556
VENÜS FOTOSELLİ LAVABO BATARYASI



Tek Su Girişli



50178
FOTOSELLİ SIVA ÜSTÜ PİSUVAR MUSLUĞU 3790.00

FİYAT / PRICE



Tek Su Girişli



50180
FOTOSELLİ SIVA ALTI PİSUVAR MUSLUĞU 3790.00

FİYAT / PRICE



Z2010
FOTOSELLİ KARIŞTIRICISI 1068.00

FİYAT / PRICE



Z2011
FOTOSELLİ KARIŞTIRICISI 638.00

FİYAT / PRICE



ENDÜSTRİYEL BATARYALAR



ENDÜSTRİYEL DUŞ SETİ TEK ÇIKIŞLI

50076

FİYAT / PRICE

4520.00



ENDÜSTRİYEL DUŞ SETİ ÇİFT ÇIKIŞLI

50106

FİYAT / PRICE

5800.00



ENDÜSTRİYEL DUŞ SETİ TEK ÇIKIŞLI

SPD-46

FİYAT / PRICE

4700.00



ENDÜSTRİYEL DUŞ SETİ TEK ÇIKIŞLI

50084

FİYAT / PRICE

6827.00



ENDÜSTRİYEL DUŞ SETİ ÇİFT ÇIKIŞLI

SPD-37

FİYAT / PRICE

5980.00



ENDÜSTRİYEL DUŞ SETİ ÇİFT ÇIKIŞLI

FS100

FİYAT / PRICE

7802.00



ENDÜSTRİYEL BATARYALAR



ENDÜSTRİYEL DUŞ SETİ TEK ÇIKIŞLI
TEZGAH ÜSTÜ

50066

FİYAT / PRICE

7084.00



ENDÜSTRİYEL TEZGAH ÖN YIKAMA DUŞ
SETİ

FS110

FİYAT / PRICE

8060.00



ENDÜSTRİYEL DUVARDAN MİX DUŞ SETİ
TEK ÇIKIŞLI

FS103

FİYAT / PRICE

7546.00



ENDÜSTRİYEL DUŞ SETİ ÇİFT ÇIKIŞLI

FS102

FİYAT / PRICE

8445.00



ENDÜSTRİYEL DUŞ SETİ TEK ÇIKIŞLI

FS113

FİYAT / PRICE

6995.00



ENDÜSTRİYEL DUŞ SETİ ÇİFT ÇIKIŞLI

FS112

FİYAT / PRICE

7931.00





ÇEKME Lİ EVİYE BATARYASI

SDB-42C

FİYAT / PRICE
3840.00



DÖNER Lİ EVİYE BATARYASI

SDB-40C

FİYAT / PRICE
2816.00



SİRALLİ EVİYE BATARYASI BASTON BORU

SPD-45K

FİYAT / PRICE
2730.00



ÇEKME Lİ EVİYE BATARYASI

SDB-42B

FİYAT / PRICE
4020.00



DÖNER Lİ EVİYE BATARYASI

SDB-40B

FİYAT / PRICE
2996.00



SİRALLİ EVİYE BATARYASI BASTON BORU

SPD-45B

FİYAT / PRICE
2910.00



BAS MUSLUKLAR



MIX BAS

FİYAT / PRICE

50333

520.00



PİSUVAR MUSLUĞU

FİYAT / PRICE

50241

368.00



ZAMAN AYARLI
PİSUVAR MUSLUĞU

FİYAT / PRICE

50242

1170.00



ZAMAN AYARLI SIVA ALTI
PİSUVAR MUSLUĞU

FİYAT / PRICE

Z2230

1391.00



ZAMAN AYARLI SIVA ÜSTÜ
PİSUVAR MUSLUĞU

FİYAT / PRICE

Z2240

1475.00



ZAMAN AYARLI 3/4 SIVA ÜSTÜ BAS

FİYAT / PRICE

Z2245

2145.00



ZAMAN AYARLI LAVABO BATARYASI
TEK SU GİRİŞLİ

FİYAT / PRICE

Z2211

2080.00



ZAMAN AYARLI LAVABO BATARYASI
ÇİFT GİRİŞLİ

FİYAT / PRICE

Z2213

4108.00



KÜRESEL BAS MUSLUKLAR

FİYAT / PRICE

51160

3/4" Küresel Bas 194.00





TEK PEDALLI ARMATÜR

FİYAT / PRICE

50248

3770.00



TEK PEDALLI ARMATÜR
ÇİFT SU GİRİŞLİ

FİYAT / PRICE

Z2262

4375.00



ÇİFT PEDALLI ARMATÜR

FİYAT / PRICE

50249

8158.00



ANKASTRE STOP VANA 1/2
PLASTİK GÖVDE

FİYAT / PRICE

50334

526.00



PEDALLI ARMATÜR
ÇIKIŞ BORUSU 18 MM

FİYAT / PRICE

B120

715.00



PEDALLI ARMATÜR
ÇIKIŞ BORUSU 22 MM

FİYAT / PRICE

B110

1170.00



1/2 - 3/8 DEKORATİF AÇ-KAPA
INOX TA HARAT

STD-01

FİYAT / PRICE

135.00



1/2 - 3/8 DEKORATİF AÇ-KAPA
INOX TA HARAT

STD-04

FİYAT / PRICE

135.00



1/2 - 3/8 DEKORATİF AÇ-KAPA
INOX TA HARAT

STD-06

FİYAT / PRICE

135.00



1/2 - 3/8 DEKORATİF AÇ-KAPA
INOX TA HARAT

STD-08

FİYAT / PRICE

135.00



1/2 - 3/8 ÇİFT ÇIKIŞLI ARA MUSLUK

9597

FİYAT / PRICE

445.00



3/4 - 3/8 ÇİFT ÇIKIŞLI ÇAMAŞIR
ARA MUSLUK

50453

FİYAT / PRICE

498.00



SPECIAL ÜRÜNLER



MİX SPİRALLİ EVİYE BATARYASI

50036

FİYAT / PRICE

2520.00



BERBER BATARYASI

50371

FİYAT / PRICE

1810.00



ARITMALI EVİYE BATARYASI

50353

FİYAT / PRICE

2880.00



ARITMA BATARYASI

50485

FİYAT / PRICE

360.00



PENCERE ÖNÜ EVİYE BATARYASI

50352

FİYAT / PRICE

2340.00



MEDİKAL BATARYA

50502

FİYAT / PRICE

1180.00



204204

Porselen Kol Mix Krom

FİYAT / PRICE

4250.00



203203

Porselen Kol Mix Siyah

FİYAT / PRICE

4250.00



205205

Porselen Kol Mix Gold

FİYAT / PRICE

5202.00



202202

Porselen Kol Mix Antik

FİYAT / PRICE

4250.00

NOSTALJİ



040040

Osmanlı Banyo Bataryası Antik

FİYAT / PRICE

3810.00



049049

Osmanlı Döner Eviye Bataryası Antik

FİYAT / PRICE

3400.00



043043

Osmanlı Kuğu Bataryası Antik

FİYAT / PRICE

2995.00



046046

Osmanlı Kartal Bataryası Antik

FİYAT / PRICE

3400.00



008008

1/2 Perlatörlü Osmanlı Musluğu Sarı

FİYAT / PRICE

1020.00

008008-A

1/2 Perlatörlü Osmanlı Musluğu Antik

1173.00

008008-B

1/2 Perlatörlü Osmanlı Musluğu Eskitme

1173.00



00001

1/2 Osmanlı Musluğu Sarı

FİYAT / PRICE

748.00

00001-A

1/2 Osmanlı Musluğu Antik

901.00

00001-B

1/2 Osmanlı Musluğu Eskitme

901.00

DUŞ SETLERİ



OSMANLI DUŞ TAKIMI ANTİK

025025

FİYAT / PRICE

17.850.00



OSMANLI DUŞ TAKIMI GOLD

026026

FİYAT / PRICE

20.400.00



OSMANLI DUŞ TAKIMI BLACK

027027

FİYAT / PRICE

17.850.00



ANKASTRE DUŞ SETLERİ



LOTUS ANKASTRE DUŞ SETİ

FİYAT / PRICE

5450.00

53300

ROYAL ANKASTRE DUŞ SETİ

FİYAT / PRICE

5450.00

53301



ANKASTRE DUVARDAN BATARYA

FİYAT / PRICE

SDA-04K

3262.00

**ANKASTRE DUVARDAN BATARYA
DÖKÜM BORULU**

FİYAT / PRICE

SDA-03B

4275.00

ANKASTRE DUVARDAN BATARYA

FİYAT / PRICE

SDA-04G

3825.00

SDA-03KD

Döküm Borulu

3994.00

SDA-03G

Döküm Borulu

4556.00

DUŞ SİSTEMLERİ



ROBOT GOLD

ROB500



FİYAT / PRICE

3300.00



ROBOT BLACK

ROB251



FİYAT / PRICE

2150.00



ROBOT BLACK OVAL

ROB250



FİYAT / PRICE

1950.00



BLACK CHROME

ROB320



FİYAT / PRICE

2600.00



KARE CHROME

ROB241



FİYAT / PRICE

2500.00



GENİŞ CHROME

ROB270



FİYAT / PRICE

2400.00

DUŞ SİSTEMLERİ



ROBOT DUŞ SETİ

FİYAT / PRICE

ROB290

2300.00



ROBOT DUŞ SETİ

FİYAT / PRICE

ROB230

2150.00



ROBOT DUŞ SETİ

FİYAT / PRICE

ROB210

1850.00



ROBOT DUŞ SETİ

FİYAT / PRICE

ROB207K

1400.00



ROBOT DUŞ SETİ

FİYAT / PRICE

ROB209

1400.00



ROBOT DUŞ SETİ

FİYAT / PRICE

ROB208

1200.00

SÜRGÜLÜ DUŞ SİSTEMLERİ



SÜRGÜLÜ DUŞ

SÜR231



FİYAT / PRICE

895.00



SÜRGÜLÜ DUŞ

SÜR210



FİYAT / PRICE

530.00



SÜRGÜLÜ DUŞ

SÜR204



FİYAT / PRICE

340.00



SÜRGÜLÜ DUŞ

SÜR209



FİYAT / PRICE

400.00



SÜRGÜLÜ DUŞ

SÜR208



FİYAT / PRICE

380.00



SÜRGÜLÜ DUŞ

SÜR207



FİYAT / PRICE

360.00

MAFSALLI VE EL DUŞLARI



FİYAT / PRICE

350.00

MAF210



FİYAT / PRICE

200.00

MAF208



FİYAT / PRICE

180.00

MAF207



FİYAT / PRICE

160.00

MAF204



FİYAT / PRICE

250.00

ELD210



FİYAT / PRICE

120.00

ELD208



FİYAT / PRICE

150.00

ELD222



FİYAT / PRICE

80.00

ELD204



FİYAT / PRICE

215.00

ANK215

TAMAMLAYICI ÜRÜNLER



DELUXE

SPR400



FİYAT / PRICE

110.00



DELUXE

SPR412



FİYAT / PRICE

195.00



DELUXE

SPR402



FİYAT / PRICE

145.00



DELUXE

SPR404



FİYAT / PRICE

90.00



DELUXE

SPR406



FİYAT / PRICE

110.00



FİYAT / PRICE

YD201

300.00



FİYAT / PRICE

SDT-21K

CHROME

1640.00

SDT-21B

BLACK

1820.00



FİYAT / PRICE

YD204

400.00



GK-1

KURU TİP, ÇOK HÜZMELİ SOĞUK SU SAYACI Multi-Jet Dry Type Cold Water Meter

SU SAYACI

GENEL ÖZELLİKLER	GENERAL FEATURES
✓ MID (Ölçü Aletleri Direktifi) Sertifikalı	✓ MID (Measuring Instruments Directive) Certified
✓ Optik Okumaya Uygunluk	✓ Suitable for Optical Reading
✓ Pulse Çıkışa Uygunluk (Opsiyonel)	✓ Suitable for Pulse Output (Optional)
✓ Çok Hüzmelili Tasarımı ile Uzun Ömür	✓ Long Service Time with Multi-jet Principle
✓ Düşük Basınç Kaybı	✓ Low Pressure Loss
✓ 360° Dönebilen Kapak	✓ 360° Rotatable Lid
✓ Çift Filtreli, Çekvalfli	✓ With Double Strainers, With Non-Return Valve
✓ Korozyona Dirençli Elektrostatik Boyalı Pirinç Gövde	✓ Electrostatic Painted Body Made of Corrosion Resistant Brass
✓ Vakumlu ve Manyetik Korunmalı Mekanizma	✓ Vacuum and Magnetic Protected Insert Mechanism
✓ 3 Yıl Garanti	✓ 3 Years of Warranty
✓ 50°C ye Kadar Olan Soğuk Sular İçin	✓ Suitable for Cold Water up to 50°C
✓ Yıllarca Yedek Parça ve Servis Sağlama	✓ Service and Spare Parts Availability for Years

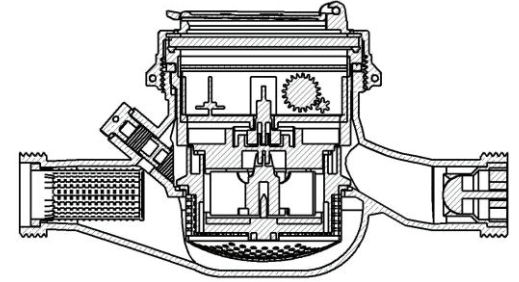

PERFORMANS ÖZELLİKLERİ/ PERFORMANCE PROPERTIES			
Anma Çapı/Nominal Diameter	DN	15	20
Aşırı Yükleme Debisi/Overload Flowrate (Q4)	m ³ /h	3,125	
Sürekli Debisi/Permanent Flowrate (Q3)	m ³ /h	2,5	
Geçiş Debisi/Transitional Flowrate (Q2)	L/h	50/40/25	
Minimum Debi/Minimum Flowrate (Q1)	L/h	31,25/25/15,625	
Q3/Q1 (MI-001 OIML R49)		80/100/160	
Şebekeye Bağlanış/ Connection to the Water Mains		Yatay/ Horizontal	
Maksimum Çalışma Basıncı/ Maximum Working Pressure	bar	16	
Maksimum Çalışma Sıcaklığı/ Maximum Operating Temperature	°C	50	
Basınç Kaybı/Pressure Loss	bar	0,63	
En Küçük Okuma Bölüntüsü/ Smallest Verification Scale	m ³	0,00005	
Maksimum Kayıt Kapasitesi/ Maximum Registration Capacity	m ³	99999	

BOYUTLAR/DIMENSIONS				
Anma Çapı/Nominal Diameter	DN	15	20	m
Bağlantı Çapı/Connection Diameter	D	G3/4B	G1B	B
Toplam Yükseklik/Total Height	H	107	107	m
Eksen Yüksekliği/Axis Height	h	32	3	mm
Boy/Length	L	165	190	m
Genişlik/Width	B	91,4	91,4	mm
Rakorlu Boy/Length with Union	LB	245	270	m
Birim Ağırlık/Unit Weight	1	,03	1,1	kg
Koli Ağırlığı(Rakorlar Hariç)/ Package Weight(Without Unions)		10,7	11,4	kg
Koli Ağırlığı(Rakorlar Dahil)/ Package Weight (With Unions)		11,9	13	kg
Koli Ebatları/Package Dimensions		24x47x22	24x47x22	c m
Kolideki Sayaç Sayısı/Quantity per Package	1	0	10	

HATA EĞRİSİ GRAFİĞİ(ERROR CURVE GRAPH)

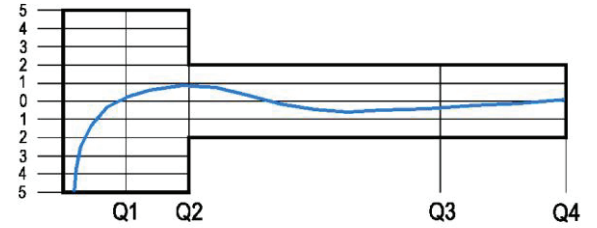

BASINÇ KAYBI GRAFİĞİ(PRESSURE LOSS GRAPH)

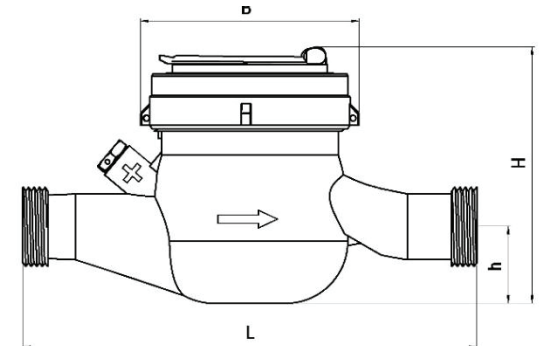
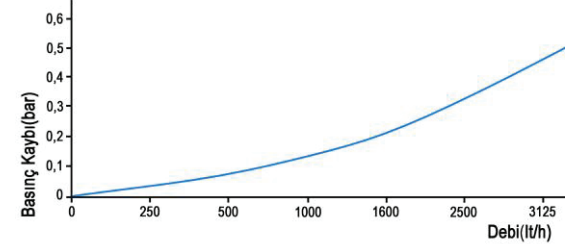

SU SAAATİ

51211

3/4 - 3/4

FİYAT / PRICE

00.00

ENGELLİ SERİSİ



Ø 19 TUTUNMA BARI

FİYAT / PRICE

53113	8.5x20 cm	SS 304	10 Ad.	248.00
53114	8.5x30 cm	SS 304	10 Ad.	271.00
53115	8.5x40 cm	SS 304	10 Ad.	297.00
53116	8.5x50 cm	SS 304	10 Ad.	319.00
53117	8.5x60 cm	SS 304	10 Ad.	341.00

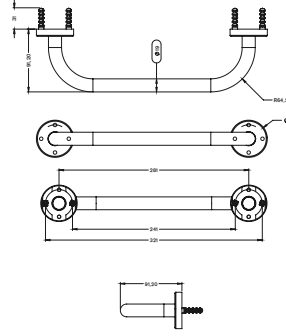

Ø 32 TUTUNMA BARI

FİYAT / PRICE

53123	8.5x30 cm	SS 304	5 Ad.	463.00
53124	8.5x40 cm	SS 304	5 Ad.	511.00
53125	8.5x50 cm	SS 304	5 Ad.	555.00
53126	8.5x60 cm	SS 304	5 Ad.	607.00

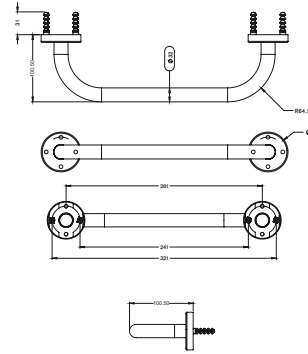

AÇILI TUTUNMA BARI

FİYAT / PRICE

53129	Ø 19 60 cm	SS 304	5 Ad.	310.00
50600	Ø 32 60 cm	SS 304	5 Ad.	629.00

ENGELLİ SERİSİ

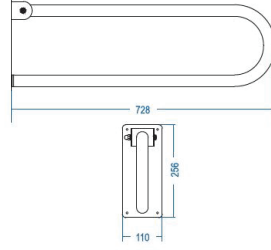
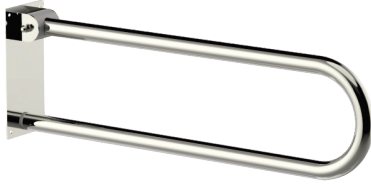

MAFSALLI TUTUNMA BARI

FİYAT / PRICE

53130

25x72 cm

SS 304

1 Ad.

1271.00

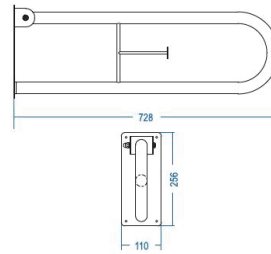
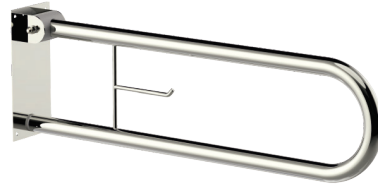

MAFSALLI WC KAĞITLIKLİ TUTUNMA BARI

FİYAT / PRICE

53131

25x72 cm

SS 304

1 Ad.

1315.00



L TİPİ TUTUNMA BARI

FİYAT / PRICE

53132

75x75 cm

SS 304

1 Ad.

835.00



BASTON AYAK TUTUNMA BARI

FİYAT / PRICE

53133

75x75 cm

SS 304

1 Ad.

1145.00



ENGELLİ OTURAĐI

FİYAT / PRICE

53134

44x50 cm

SS 304

5 Ad.

1634.00



ENGELLİ AYNASI

FİYAT / PRICE

53135

60x70 cm

SS 304

5 Ad.

1590.00



PASLANMAZ SIVI SABUNLUK

FİYAT / PRICE

53264

500 ML PLASTİK POMPA SIVI SABUNLUK

713.00

53263

1000 ML PLASTİK POMPA SIVI SABUNLUK

783.00





LAMALI RAF HAVLULUK

FİYAT / PRICE

53266

839.00

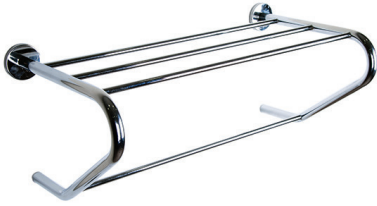

DESTEKLİ RAF HAVLULUK

FİYAT / PRICE

53267

856.00

SOPRANO



UZUN HAVLULUK

53040

FİYAT / PRICE

490.00



BORNOZ ASKILIĞI

53037

FİYAT / PRICE

230.00



DİŞ FIRÇALIK

53034

FİYAT / PRICE

314.00



SABUNLUK

53038

FİYAT / PRICE

314.00



WC KAĞITLIK

53035

FİYAT / PRICE

307.00



KAPAKLI WC KAĞITLIK

53039

FİYAT / PRICE

380.00



YUVARLAK HAVLULUK

53036

FİYAT / PRICE

246.00

SOPRANO BLACK



UZUN HAVLULUK

53048



FİYAT / PRICE

490.00



BORNOZ ASKILIĞI

53045



FİYAT / PRICE

230.00



DİŐ FIRÇALIK

53042



FİYAT / PRICE

314.00



SABUNLUK

53046



FİYAT / PRICE

314.00



WC KAĞITLIK

53043



FİYAT / PRICE

307.00



KAPAKLI WC KAĞITLIK

53047



FİYAT / PRICE

380.00



YUVARLAK HAVLULUK

53044



FİYAT / PRICE

246.00



ETAJER

53049



FİYAT / PRICE

167.00



BORNOZ ASKILIĞI

53053



FİYAT / PRICE

88.00



DİŞ FIRÇALIK

53050



FİYAT / PRICE

140.00



SABUNLUK

53054



FİYAT / PRICE

140.00



WC KAĞITLIK

53051



FİYAT / PRICE

115.00



KAPAKLI WC KAĞITLIK

53055



FİYAT / PRICE

147.00



YUVARLAK HAVLULUK

53052



FİYAT / PRICE

115.00



UZUN HAVLULUK

53056



FİYAT / PRICE

124.00



WC KAĞITLIK

RU002



FİYAT / PRICE

202.00



KAPAKLI WC KAĞITLIK

RU001



FİYAT / PRICE

237.00



YUVARLAK HAVLULUK

RU006



FİYAT / PRICE

314.00



UZUN HAVLULUK

RU005



FİYAT / PRICE

380.00



BORNOZ ASKILIĞI

RU010



FİYAT / PRICE

177.00

ARYA



UZUN HAVLULUK

53064



FİYAT / PRICE

110.00



BORNOZ ASKILIĞI

53061



FİYAT / PRICE

66.00



DİŞ FIRÇALIK

53058



FİYAT / PRICE

62.00



SABUNLUK

53062



FİYAT / PRICE

62.00



WC KAĞITLIK

53059



FİYAT / PRICE

63.00



KAPAKLI WC KAĞITLIK

53063



FİYAT / PRICE

82.00



YUVARLAK HAVLULUK

53060



FİYAT / PRICE

75.00

ARYA BLACK



UZUN HAVLULUK

FİYAT / PRICE

53072

128.00



BORNOZ ASKILIĞI

FİYAT / PRICE

53069

76.00



DİŞ FIRÇALIK

FİYAT / PRICE

53066

118.00



SABUNLUK

FİYAT / PRICE

53070

118.00



WC KAĞITLIK

FİYAT / PRICE

53067

75.00



KAPAKLI WC KAĞITLIK

FİYAT / PRICE

53071

97.00



YUVARLAK HAVLULUK

FİYAT / PRICE

53068

89.00



www.guneyvana.com